



2021



www.vignal-group.com



Photos à 360°
360° pictures
360° Fotos



Fiches produits détaillées
Detailed product sheets
Detaillierte Produktblätter



Centre de téléchargement
Download center
Download-Center



Aide questions produits
Product questions help
Produktfragen helfen



PRODUITS D'ORIGINE CONSTRUCTEURS
 OE SPARE PARTS PER MANUFACTURER
 ORIGINALERSATZTEILE NACH FAHRZEUGHERSTELLER

ASCA.....	8
BENALU.....	12
BOBCAT.....	14
CASE.....	16
CATERPILLAR.....	17
CHEREAU.....	19
CLAAS.....	22
DAF.....	23
DE BUF.....	28
DOOSAN.....	30
FELDBINDER.....	32
FIAT.....	34
FRUEHAUF.....	35
GUILLEN.....	37
HEULIEZ.....	39
HYUNDAI CONSTRUCTION EQUIPMENT.....	41
IVECO.....	43
IVECO BUS.....	54
KUBOTA.....	60
LAMBERET.....	61
LECAPITAINE.....	65
LECIÑENA.....	66
LINDE.....	68
MAGYAR.....	69
MAN.....	70
MANITOU.....	73
MANITOWOC.....	75
MERCEDES.....	76
MERLO.....	79
NEW HOLLAND.....	80
NISSAN.....	81
OMEPS.....	82
OPEL.....	84
PEUGEOT CITROËN.....	85
RENAULT TRUCKS.....	86
SAME.....	114
SCANIA.....	115
SCHMITZ.....	117
SOR IBERICA.....	119
STEYR.....	121
STILL.....	122
TROUILLET.....	123
UD TRUCKS.....	124
VF VENIERI.....	125
VOLKSWAGEN.....	126
VOLVO.....	127
VOLVO CONSTRUCTION BUS.....	136

SIGNALISATION - SIGNALLING - SIGNALISIERUNG

Feux arriere - Rear lamps - Heckleuchten.....	137
Eclaireurs de plaque - Number plate lamps - Kennzeichenleuchten	178
Feux clignotants - Flasher lamps - Fahrtrichtungsanzeiger	182
Feux de position- Position lamps - Positionsleuchten.....	189
Feux de gabarits - End outline marker lamps - Begrenzungsleuchten.....	206
Signalisation passive - Warning products - Warnmarkierungen.....	213

ECLAIRAGE - LIGHTING - BELEUCHTUNG

Phares de recul - Reverse work lights - Rückfahrlicht Arbeitsscheinwerfer	218
Phares de travail - Work Lights - Arbeitsscheinwerfer.....	221
Éclairage de sécurité - Warning Lights - Sicherheitsbeleuchtungen	238
Phares de conduite - Headlights - Fahrlichter	240
Feux auxiliaire - Auxiliary Lights - Zusatzsscheinwerfer.....	245
Éclairage intérieur - interior Lights - innenraum-Beleuchtungen.....	248

PRODUITS DE SÉCURITÉ - SAFETY PRODUCTS - SICHERHEITSPRODUKT

Gyrophares - Beacons - Rundumkennleuchten.....	251
Rampes lumineuses - Lightbars - Warnbalken	264
Triflash.....	268
Feux de pénétration - Directional light - Warnleuchten	271
Alarmes sonores de recul - Back up alarms - Rückfahrwarner	273
Systèmes caméras - Camera systems - Kamera-Systeme	275
Coffres porte extincteur - Extinguisher boxes - Feuerlöscher Behälter	291

ÉLECTRIQUE-ÉLECTRONIQUE - ELECTRICAL-ELECTRONICS - ELEKTRISCH-ELEKTRONISCHE

Prises et câbles spiralés - Plugs and coils - Stecker und Spiralkabel.....	293
Connecteurs - Connectors - Anschlussstecker.....	299
Faisceaux - Harnesses - Kabelsatz.....	304
Systèmes câblage et feux - Wiring and lamps systems - Verkabelung und leuchten systeme	313

RECHERCHE PRODUITS - PRODUCTS RESEARCH - PRODUKTSUCHE

Par liste de correspondance - By cross list - nach Hersteller-Nr	319
Par référence - By part number - nach Artikelnummer	323
Par no. d'homologation - By homologation number - nach Homologationsnummer	327
Par photo - By pictures - nach Abbildung	328

Ce catalogue n'est pas contractuel
This catalogue does not create any contractual tie
Die Informationen in diesem Katalog sind nicht bindend !
Wir behalten uns ausdrücklich vor, eventuelle Prospektangaben zu ändern

Vignal Group, le spécialiste de l'éclairage et de la sécurité pour véhicules industriels et commerciaux.

Vignal Group, the lighting and safety specialist for industrial and commercial vehicles.

Vignal Group, der Beleuchtungs- und Sicherheitspezialist für Industrie- und Nutzfahrzeuge.



Un savoir faire unique
A unique know-how
Ein einzigartiges Fachwissen



Des produits de qualité
Quality products
Detaillierte Produktblätter



Des années d'expertise
Years of expertise
Langjährige Erfahrung



Des marques validées par les constructeurs.

OE approved brands.

Vom Fahrzeughersteller validierte Marken.



Notre philosophie est de concevoir globalement et de produire localement. Nos 5 sites sont présents sur trois continents pour vous offrir la meilleure flexibilité pour le meilleur service possible.

Our philosophy is to have a global design for a local production. Our 5 sites are located on three continents to offer you more flexibility for a better service.

Unsere Philosophie ist es, global zu designen und lokal zu produzieren. Unsere 5 Standorte befinden sich auf drei Kontinenten, um Ihnen die bestmögliche Flexibilität und den bestmöglichen Service zu bieten.



Vignal a fait du développement durable l'un de ses axes stratégiques majeurs.

Vignal has turned sustainable development into one of its main strategic focus.

Vignal hat die nachhaltige Entwicklung zu einem seiner strategischen Hauptschwerpunkte gemacht.



SECTEURS INDUSTRIES BRANCHEN



Produits d'origine constructeurs

OE spare parts per manufacturer

Originalersatzteile Fahrzeughersteller



K Catadioptr
Reflector
Rückstrahler

T Catadioptr triangulaire
Triangular reflector
Dreieckrückstrahler

FPL Feu de position latéral
Side marker lamp
seitenmarkierungsleuchte

EPP Eclaireur de plaque
Number plate lamp
Kennzeichenleuchte

Al Alarme sonore de recul
Back up alarm
Rückfahrhorn

CC Connecteurs additionnels
Additional connectors
Zusätzliche elektrische anschlüsse

AMP 1.5-7P-M



Type connecteur - Nb pins - Mâle ou Femelle
Connector type - Pins Nb - Male or Female
Steckertyp - Stifte Nb - männlich oder weiblich

Flashez le QR code pour plus d'infos
Scan the QR code for more info
Scannen Sie den QR-Code für weitere Informationen



Pièces détachées
Spare parts
Ersatzteile

08/2020 ->

Dates d'application
Application dates
Baujahr



p. 154

Numéro page produit standard
Standard product page number
Standardproduktseitennummer



Faisceau p. 299
Harness p. 299
Anschlusskabel siehe S. 299

DETAIL CONNECTEUR 1.5	Support des Pinces des Connecteurs Précabloc	FONCTION FUNCTION
1	1	MALE MÂLE
2	2	POSITION Tête
3	3	REDA ROUGE
4	4	INDICATEUR DE DIRECTION INDICATOR
5	5	STOP
6	6	MODULARE
7	7	NOT USED

Pinning connecteurs sur notre site web
Connectors pinning on our website
Anschlüsse feststecken auf unsere Website

LC12T LED

 p. 138

LED

 24V



161000

gauche - left - links



AMP 1.5-7P-M

arrière
rear connector
Anschlusstecker hinten



161010

droit - right - rechts



D11868

AMP 1.5-7P-F

LC8T

 p. 157



156040

gauche - left - links



AMP 1.5-7P-M

arrière
rear connector
Anschlusstecker hinten



156050

droit - right - rechts



156060

gauche - left - links



D11868

AMP 1.5-7P-F



056700

gauche - left - links



056710

droit - right - rechts



LC5TDX ⓘ p.165



153660

gauche - left - links



AMP 1.5-7P-M

arrière
rear connector
Anschlussstecker hinten



153670

droit - right - rechts



D11868

AMP 1.5-7P-F



053700

gauche - left - links



053710

droit - right - rechts



LC5T ⓘ p.164



153000

gauche - left - links



AMP 1.5-7P-M

arrière
rear connector
Anschlussstecker hinten



153010

droit - right - rechts



153020

gauche - left - links



D11868

AMP 1.5-7P-F



053700

gauche - left - links



053710

droit - right - rechts



EPP96 ⓘ p.181



D10502

410 mm

CLICK-IN

EPP96 LED

 p. 180

LED

 24V



D13609 400 mm
CLICK-IN

FE04

 p. 190

LED

 24V



104310 5000 mm



D10132 200 mm

SMD98

 p. 191

LED

 24V



D11399 1500 mm **K**
CLICK-IN



001716

SMD04

 p. 196

LED

 24V



104140 1500 mm **K**
CLICK-IN



104100 1500 mm **K**
CLICK-IN



104260 1500 mm **K**
CLICK-IN



104220 1500 mm **K**
CLICK-IN

DXLC8 p. 158



D13034

gauche - left - links

CLICK-IN



D13035

droit - right - rechts

CLICK-IN

DX p. 209



D12428

W5W

1400 mm

CLICK-IN

FA3LED p. 207

LED

 12/24V



D14427

gauche - left - links

1500 mm

CLICK-IN



D14428

droit - right - rechts

1500 mm

CLICK-IN

MDJ p. 145



175020

BENALU

LC12 LED p. 138

LED

 24V



161000
gauche - left - links



AMP 1.5-7P-M
arrière
rear connector
Anschlusstecker hinten



161010
droit - right - rechts



LC8T p. 157



156040
gauche - left - links



AMP 1.5-7P-M
arrière
rear connector
Anschlusstecker hinten



156050
droit - right - rechts



D11868 **AMP 1.5-7P-F**



056700
gauche - left - links



056710
droit - right - rechts



001830



SMD04 p. 196



LED

 24V



104140 1500 mm 
CLICK-IN





104090 500 mm 
104100 1500 mm 
CLICK-IN



104260 1500 mm 
CLICK-IN



104640 300 mm 
104650 1000 mm 

bride rallongée - extended bracket - Montagewinkel verlängerter
CLICK-IN

+18mm

SMD98 p.191

LED

 24V



D11399 1500 mm

CLICK-IN



001716

DXLC8 p.158



D12712

gauche - left - links

POS-2P-F



D12711

droit - right - rechts

POS-2P-F

ASR p.274

 12/24V

Multi-Frequency



D13810

1500 mm

97 dB



CLICK-IN

Standard



630120

87 dB



MDJ p.145



175020

LC12 LED

 p. 138

LED

 12V



D161140
(OE 7322387)

gauche - left - links





AMP 1.5-7P-M
arrière
rear connector
Anschlusstecker hinten



D161150
(OE 7322388)

droit - right - rechts





D11868 AMP 1.5-7P-F

CHL 1 LED

 p. 242

LED

 12V



D14324
(OE 7348957)

gauche - left - links

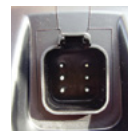

DT-6P-M
arrière
rear connector
Anschlusstecker hinten



D14325
(OE 7348958)

droit - right - rechts



D14352 DT-6P-F

RL 1500

 p. 225

LED

 12/24V

 1500 Lumen



D14854
(OE 7387145)

DT-2P-M

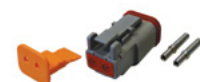

D14170 DT-2P-F

TELESCOPIC

GALAXY LED

 p. 255

LED

 12/24V



D14488
(OE 7322390)



D14513

TL470, MF9000

LC5

 p. 161



152150
(OE 7164111)
gauche - left - links





PG
arrière
rear connector
Anschlusstecker hinten



152150
(OE 7164110)
droit - right - rechts





052500
(OE 7027476)
gauche - left - links





052500
(OE 7027476)
droit - right - rechts





R12931 - 1200 mm
(OE 7028786)





R12934 - 600 mm
(OE 7028787)



EPP98

 p. 181



196010
(OE 7175124)





D13876



LPL18

 p. 179

LED

 12/24V

08/2020 ->

NEW



199000
(OE 47363002)

SS-2P-M



D13880

SS-2P-F

SMD98

 p.197

LED

 12V

08/2018->



198810
(OE 5141966)

SS-2P-M



D13880

SS-2P-F

SH3

 p. 236

 H3/70W
12V

08/2018 ->



D14156

DT-2P-M



D14170

DT-2P-F

FT

 p. 234

LED

 12/24V

07/2017 ->



D14191
(OE 47826594)



D14192

SL 1000 p.222

LED

 12/24V

 1000 Lumen



D14850

DT-2P-M



D14170

DT-2P-F

SL 1500 p.223

LED

 12/24V

 1500 Lumen



D14851

DT-2P-M



D14170

DT-2P-F

SLA 2000 p.223

LED

 12/24V

 2000 Lumen



D14852

DT-2P-M



D14170

DT-2P-F

RL 1000 p.225

LED

 12/24V

 1000 Lumen



D14853

DT-2P-M



D14170

DT-2P-F

RL 1500

 p.225

LED

 12/24V

 1500 Lumen



D14854

DT-2P-M



D14170

DT-2P-F

RLA 2000

 p.225

LED

 12/24V

 2000 Lumen



D14855

DT-2P-M



D14170

DT-2P-F

SH3

 p.236

 H3/70W
24V



D14156

DT-2P-M



D14170

DT-2P-F

RH3

 p.236

 H3/70W
24V



D14654

DT-2P-M



D14170

DT-2P-F

BL15-CTL15 p. 145

LED

 24V



Exemple de montage - Assembly suggestion - Montagebeispiel



DT04-4P-M



164000
(OE 21153)



DT04-4P-M



DTM04-4P-M



164010
(OE 21154)

Pour raccordement sur feu BL15
To plug in BL15 lamp
Zum direkten Anschluss an die leuchte BL15



165020
(OE 21781)

gauche - left - links



DT04-4P-M



DTM06-4S-4P-F



165030
(OE 21155)

droit - right - rechts



D14436 DT06-4S-4P-F



D14437 DTM06-4S-4P-F



D14435 DTM04-4P-M

LC12 LED p. 138

LED

 24V

NEW



161000

gauche - left - links



AMP 1.5-7P-M
arrière
rear connector
Anschlussstecker hinten

NEW



161010

droit - right - rechts



D11868 AMP 1.5-7P-F

LC8T

 p. 157



156040

gauche - left - links



AMP 1.5-7P-M

arrière
rear connector
Anschlusstecker hinten



156050

droit - right - rechts



156060

gauche - left - links



156070

droit - right - rechts



D11868

AMP 1.5-7P-F



056700

gauche - left - links



056710

droit - right - rechts



LC8

 p. 154



156550

gauche - left - links



AMP 1.5-7P-M

arrière
rear connector
Anschlusstecker hinten

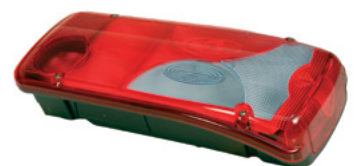

156540

droit - right - rechts



D11868

AMP 1.5-7P-F

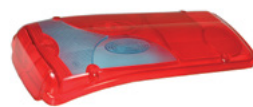

056000

gauche - left - links

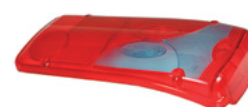

056010

droit - right - rechts



001846

LC5T p. 164



153020

gauche - left - links



AMP 1.5-7P-M

arrière
rear connector
Anschlussstecker hinten



153010

droit - right - rechts



D11868

AMP 1.5-7P-F



053700

gauche - left - links

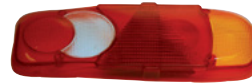

053710

droit - right - rechts



EPP96 p. 181



196020

R10W

SL 1000 p. 219

LED

 12/24V

 **R23**



D14857

DT-2P-M

Feu homologué recul - Homologated reverse lamp -
Genehmigt Rückfahrleuchte



D14170

DT-2P-F

09/2019 ->

NEW



9/32V



212400
(OE 27108471)



196020
(OE 7700027564)

04/2012 ->



155100
(OE 1875577)   
gauche - left - links



HDSCS-8P-M
latéral
side connector
Anschlusstecker seitlich



155110
(OE 1875576)  
droit - right - rechts



Entraxe : 160 mm
Bolt distance : 160 mm
Schraubenabstand : 160 mm



155120
(OE 1875578)   
droit - right - rechts

04/2012 ->



155130
(OE 1875580)   
gauche - left - links



HDSCS-8P-M
arrière
rear connector
Anschlusstecker hinten



155140
(OE 1875579)  
droit - right - rechts



155150
(OE 1875581)   
droit - right - rechts



D13878 **HDSCS-8P-F**



055020
(OE 1914690) 
gauche - left - links



055030
(OE 1914691) 
droit - right - rechts



001830
(OE 1973239) 
Alarme sonore de recul
Back up alarm
Rückfahrtsignalhorn

1995 -> 04/ 2012



1995 ->2001



167640
(OE 1284211)  

168020
(OE 1304789)   

gauche - left - links



DAF
arrière
rear connector
Anschlusstecker hinten



167630
(OE 1284212) 

168010
(OE 1304788)  

droit - right - rechts



168890
(OE 1660967)   

droit - right - rechts

2001 -> 04/2012



169160
(OE 1625985)   

gauche - left - links



AMP 1.5-7P-M
latéral
side connector
Anschlusstecker seitlich



169170
(OE 1625986)  

droit - right - rechts



169380
(OE 1660968)   

droit - right - rechts



D11868 **AMP 1.5-7P-F**



067500
(OE 1272653) 

gauche - left - links



067500
(OE 1272653) 

droit - right - rechts



D12953
(OE 1519358) 

Alarme sonore de recul
Back up alarm
Rückfahrsignalhorn

1993 ->



109010
(OE 1814096/1815754)

CF/XF

ICDL10

 p. 186

01/2013 ->



117000
(OE 1846491)

gauche - left - links



117010
(OE 1846492)

droit - right - rechts



001619

75 - 85 - XF - CF

FPL93

 p. 200



193020
(OE 1329718)

K

JPT-2P-M



193200
(OE 1653605)

K

JPT-2P-M



001726
(OE 1608352)



D13876

JPT-2P-F

LF

LC5

 p. 161

2001 ->



152170
(OE 1401713)

K

EPP

gauche - left - links



AMP 1.5-7P-M

arrière
rear connector
Anschlussstecker hinten



152180
(OE 1401731)

K

droit - right - rechts



D11868 AMP 1.5-7P-F



052500
(OE 1451482)

K

gauche - left - links



052500
(OE 1451482)

K

droit - right - rechts

FE95

 p. 193



195010
(OE 1403887)
gauche - left - links



195010
(OE 1403887)
droit - right - rechts

ICDL94

 p. 187



119550
(OE 1626101)

JPT-3P-M



001616
(OE 1626102)



D13877 **JPT-3P-F**

FE02

 p. 193



102200 **K**
clippé - clipped - befestigung **JPT-2P-M**



001726
(OE 1608352)



D13876 **JPT-2P-F**

FPL93

 p. 200



193020 **K**
(OE 1329718) **JPT-2P-M**



001726
(OE 1608352)



D13876 **JPT-2P-F**

EPP98

 p. 181



196010
(OE 0867930) **JPT-2P-M**



D13876 **JPT-2P-F**

65 - 75 - 85 - 95

LC4

 p. 171

-> 1993

* Silent blocs non fournis, voir réf. 001706 p. 170

* Silent blocs not supplied, see p/n 001706 p. 170

* Schwingungsdämpfer Art.-Nr. 001706 nicht im Lieferumfang, Seite p. 170



141500
(OE 2922224)  

gauche - left - links



PE
arrière
rear connector
Anschlusstecker hinten



141500
(OE 2922224)  

droit - right - rechts



040500
(OE 0698603) 

gauche - left - links



040500
(OE 0698603) 



droit - right - rechts

LC7

 p. 166

1993 -> 1995





168100
(OE 1626319/1284213)   

gauche - left - links



DIN
arrière
rear connector
Anschlusstecker hinten



168390
(OE 1626320/1284214)   

droit - right - rechts



067500
(OE 1272653) 

gauche - left - links



067500
(OE 1272653) 

droit - right - rechts

DE BUF

LC12 LED p. 138

LED

 24V



161000

gauche - left - links



AMP 1.5-7P-M
arrière
rear connector
Anschlusstecker hinten



161010

droit - right - rechts



D11868 **AMP 1.5-7P-F**

SMD04 p. 196

LED

 24V



104140

1500 mm



CLICK-IN



104100

1500 mm



CLICK-IN

FA3 LED p. 207

LED

 12/24V



D14425

gauche - left - links

SS-2P-F



D14426

droit - right - rechts

SS-2P-F

SL 1000 p. 219

LED

 12/24V

 R23



D14857

DT-2P-M

Feu homologué recul - Homologated reverse lamp -
Genehmigt Rückfahrleuchte



D14170

DT-2P-F

SHD 1200

 p. 227

LED

 12/24V



D14161

DT-2P-M



D14170

DT-2P-F

ATLAS

 p. 252

LED

 12/24V



212420



D14513

EPP96 LED

 p. 180

LED

 24V



R14364

2000 mm

SS-2P-F

DOOSAN

CHL 1 H4

i | p. 243

 24V
H4 - PY21 - W5W



D14322
gauche - left - links



DT-6P-M
arrière
rear connector
Anschlussstecker hinten



D14323
droit - right - rechts



D14352 **DT-6P-F**

SL 1500

i | p. 223

LED

 12/24V

 1500 Lumen



D14971
DT-2P-M



D14170 **DT-2P-F**

SLA 2000

i | p. 223

LED

 12/24V

 2000 Lumen



D14852
DT-2P-M



D14170 **DT-2P-F**

RH3

i | p. 236

 H3/55W
12V



D14654
DT-2P-M



D14170 **DT-2P-F**

SH3

 p. 236

 H3/70W
12V



D14156

DT-2P-M



D14170

DT-2P-F

QH3

 p. 236

 H3/70W
12V



D14159

DT-2P-M



D14170

DT-2P-F

FELDBINDER

LC12 LED p. 138

LED
24V



161000

gauche - left - links



AMP 1.5-7P-M

arrière
rear connector
Anschlusstecker hinten



161010

droit - right - rechts



D11868

AMP 1.5-7P-F

LC8T p. 157



156250

gauche - left - links



AMP 1.5-7P-M

arrière
rear connector
Anschlusstecker hinten



156260

droit - right - rechts



D11868

AMP 1.5-7P-F



056720

gauche - left - links



056730

droit - right - rechts



SMD04 p. 196

LED
24V



104140

1500 mm



CLICK-IN



104260

1500 mm



CLICK-IN

SMD98

 p.197

LED

 24V



D10500 500 mm 

D11399 1500 mm 

CLICK-IN



D10497 500 mm 

CLICK-IN

FA3 LED p. 207

LED

 12/24V



D14425

gauche - left - links

SS-2P-F



D14426

droit - right - rechts

SS-2P-F

DXLC8 p. 158



D12712

gauche - left - links

POS-2P-F



D12711

droit - right - rechts

POS-2P-F

ASR p. 274

 12/24V

Standard



630120

87 dB



07/2012 ->



Fixation 4 vis M6 (190x60mm)
Fixing 4 screws M6 (190x60mm)
Befestigung 4 Schrauben M6
(190x60mm)



153270
(OE 1372699080)

gauche - left - links





AMP 1.5-7P-M

arrière
rear connector
Anschlussstecker hinten



153280
(OE 1372698080)

droit - right - rechts





D11868 **AMP 1.5-7P-F**



052500
gauche - left - links





052500
droit - right - rechts





193360
(OE 1356794080 / 71749250)



SS-2P-M



193170
(OE 1305797)



SS-2P-M



001916



D13880

SS-2P-F

LC12 LED p. 138



161000 
gauche - left - links



AMP 1.5-7P-M
arrière
rear connector
Anschlusstecker hinten



161010 
droit - right - rechts

LC8T p. 157



156040  
gauche - left - links



AMP 1.5-7P-M
arrière
rear connector
Anschlusstecker hinten



156050  
droit - right - rechts



D11868 **AMP 1.5-7P-F**



056700 
gauche - left - links



056710 
droit - right - rechts



001830 

BL15 p. 171



NEW



165040
gauche - left - links



DT04-4P-M



DTM06-4S-4P-F

NEW



165050
droit - right - rechts



D14436 **DT06-4S-4P-F**



D14437 **DTM06-4S-4P-F**



D14435 **DTM04-4P-M**

EPP96 LED p. 180



D13609 400 mm
CLICK-IN

FRUEHAUF

EPP96

 p. 181



196020

R10W



D11888

1000 mm

CLICK-IN

DXLC8

 p. 158



D12712

350 mm

gauche - left - links

POS-2P-F



D12711

350 mm

droit - right - rechts

POS-2P-F

FA3 LED

 p. 207

LED



12/24V



D14427

1500 mm

gauche - left - links

CLICK-IN



D14428

1500 mm

droit - right - rechts

CLICK-IN

SMD04

 p. 196

LED



24V



104130

500 mm



104140

1500 mm



CLICK-IN



104090

500 mm



104100

1500 mm



CLICK-IN

5054

 p. 292



Max 6 kg

D14538

LC12 LED



p. 138

LED



24V



161000

gauche - left - links



AMP 1.5-7P-M

arrière
rear connector
Anschlussstecker hinten



161010

droit - right - rechts



D11868

AMP 1.5-7P-F



D14781

gauche - left - links

SS-2P-F



D14782

droit - right - rechts

SS-2P-F

LC8T



p. 157



156040

gauche - left - links



FPL



AMP 1.5-7P-M

arrière
rear connector
Anschlussstecker hinten



156050

droit - right - rechts



FPL



056700

gauche - left - links



056710

droit - right - rechts



D12712

gauche - left - links

POS-2P-F



D12711

droit - right - rechts

POS-2P-F



D11868

AMP 1.5-7P-F

EPP96 LED



p. 180

LED



24V



R14364

2000 mm

SS-2P-F

GUILLEN

EPP96

 p. 181



D11888

1000 mm

CLICK-IN

SMD04

 p. 196

LED

 24V



104100

1500 mm **K**

CLICK-IN



104650

1000 mm **K**

bride rallongée - extended bracket - Montagewinkel verlängerter

CLICK-IN

SMCU

 p. 196

 12/24V



D14722

SS-2P-M SS-3P-M

FA3LED

 p. 207

LED

 12/24V



D14427

1500 mm

gauche - left - links

CLICK-IN



D14428

1500 mm

droit - right - rechts

CLICK-IN

GX

LC6

 p. 170



166500





PE
arrière
rear connector
Anschlussstecker hinten



066500



cabochon - lens - Lichtscheibe

LC7

 p. 166



167150

(OE 2773801/2870801)



067000

(OE 3156201)

cabochon - lens - Lichtscheibe

FE81

 p. 212



181000

(OE 0190408700)



181050

(OE 0190552400)

FE85

 p. 194



185020

(OE 5010217022)



185050

(OE 5010104837)

FE95

 p. 193



195030

(OE 5010271501)



195060

(OE 5010312524)

FPL93

 p. 200



193020
(OE 190825600)

K

JPT-2P-M



001726



D13876

JPT-2P-F

ICDL94

 p. 187



119550

JPT-3P-M



001616



D13877

JPT-3P-F



001626

HYUNDAI CONSTRUCTION EQUIPMENT

CHL 1 LED

 p. 242

LED

 12/24V



D14324

gauche - left - links

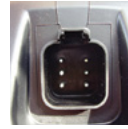

DT-6P-M
arrière
rear connector
Anschlusstecker hinten



D14325

droit - right - rechts



D14352

DT-6P-F

CHL 1 H4

 p. 243

 24V
H4 - PY21 - W5W



D14320

12V

D14322

24V

gauche - left - links



DT-6P-M
arrière
rear connector
Anschlusstecker hinten



D14321

12V

D14323

24V

droit - right - rechts



D14352

DT-6P-F

SL 1500

 p. 223

LED

 12/24V

 1500 Lumen



D14971

DT-2P-M



D14170

DT-2P-F

HYUNDAI CONSTRUCTION EQUIPMENT

SH3

 p. 236

 H3/70W
24V



D14156

DT-2P-M



D14170

DT-2P-F

ATLAS

 p. 252

LED

 9/32V



212460



STRALIS / TRAKKER

LC11

 p. 140

LED

 24V

03/2016 ->



160150  
(OE 5802062689 / 5802240291)
gauche - left - links



HDSCS-8P-M
latéral
side connector
Anschlussstecker seitlich





160100  
(OE 5802000573 / 5802240295)
droit - right - rechts



160080   
(OE 5802000568 / 5802240292)
gauche - left - links



160090   
(OE 5802000767 / 5802240296)
droit - right - rechts

03/2016 ->



160110  
(OE 5802000570 / 5802240293)
gauche - left - links



HDSCS-8P-M
arrière
rear connector
Anschlussstecker hinten



160130  
(OE 5802000770 / 5802240297)
droit - right - rechts



160140   
(OE 5802055273 / 5802240294)
gauche - left - links



160120   
(OE 5802000772 / 5802240298)
droit - right - rechts



D13878 **HDSCS-8P-F**



060000 
gauche - left - links



060010 
droit - right - rechts

03/2016 ->



155450
(OE 5801637199)   
gauche - left - links



HDSCS-8P-M
latéral
side connector
Anschlusstecker seitlich



155460
(OE 5801637201)  
droit - right - rechts



155470
(OE 5801637202)   
droit - right - rechts

DESIGN EFFET FUMÉ - MÉTALLISÉ
SMOKED EFFECT & METTALIZED DESIGN
DESIGN RAUCHEFFEKT - METALLEFFEKT

03/2016 ->



155480
(OE 5801637182)  
gauche - left - links



HDSCS-8P-M
arrière
rear connector
Anschlusstecker hinten



155490
(OE 5801757328)  
droit - right - rechts



155540
(OE 5802055272)   
gauche - left - links



155500
(OE 5801757326)   
droit - right - rechts



D13878 **HDSCS-8P-F**



055040
gauche - left - links



055050
droit - right - rechts



001830
Alarme sonore de recul
Back up alarm
Rückfahrhorn



STRALIS - TRAKKER - EURO CARGO

LC5

 p.161

06/2011 -> EURO 6



153220
(OE 5801426889) 
gauche - left - links



AMP 1.5-7P-M
arrière
rear connector
Anschlussstecker hinten



153210
(OE 5801426894) 
droit - right - rechts



153200
(OE 5801426912)  
gauche - left - links



153230
(OE 5801426917)  
droit - right - rechts



153240
(OE 5801426975) 
gauche - left - links



153250
(OE 5801426977) 
droit - right - rechts

153260
(OE 5801426979)  
droit - right - rechts



D11868 **AMP 1.5-7P-F**



052500
(OE 42566495) 
gauche - left - links



052500
(OE 42535711) 
droit - right - rechts

FPL93

 p. 200



193020
(OE 500308514) 
JPT-2P-M



001726
(OE 1608352)



D13876 **JPT-2P-F**

SMD98

 p. 197

-> 10/2014

 LED

 24V



198760
(OE 5801631615) 
SS-2P-M



D13880 **SS-2P-F**

LC7

 p. 168

09/2011 -> EURO 6



169390
(OE 5801363428)  
gauche - left - links



DIN-8P-M
arrière
rear connector
Anschlussstecker hinten





169410
(OE 5801363431)  
droit - right - rechts



169400
(OE 5801363430)   
gauche - left - links



169420
(OE 5801363432)   
droit - right - rechts



067500
(OE 93161844) 
gauche - left - links



067500
(OE 93161844) 
droit - right - rechts



D12953 

STRALIS - TRAKKER - ASTRA HD7/HD8

C105

 p. 183

09/2012 ->



110550
(OE 5801572024)
gauche - left - links



110560
(OE 5801572018)
droit - right - rechts





001619

FPL93

 p. 200



193170
(OE 41200664) 
superseal 



001916



D13880 

STRALIS - TRAKKER - ASTRA HD7/HD8

LC7

 p.167

2002 ->



168610
(OE 99463244)
gauche - left - links



IVECO
arrière
rear connector
Anschlusstecker hinten



168600
(OE 99463242)
droit - right - rechts



168480
(OE R504083205)
droit - right - rechts



067500
(OE 93161844)
gauche - left - links



067500
(OE 93161844)
droit - right - rechts



D12953



C199

 p.183

2002 -> 05/2007



119920
(OE 41221041)
gauche - left - links



119930
(OE 41221040)
droit - right - rechts

C105

 p.183

05/2007 -> 09/2012



110520
(OE 42555042)
gauche - left - links



110530
(OE 42555041)
droit - right - rechts



001619

1996 ->



168590
(OE 99463243)
gauche - left - links



IVECO
arrière
rear connector
Anschlusstecker hinten



168600
(OE 99463242)
droit - right - rechts



168610
(OE 99463244)
gauche - left - links



067500
(OE 93161844)
gauche - left - links



067500
(OE 93161844)
droit - right - rechts



06/2008 -> 09/2012



110520
(OE 42555042)
gauche - left - links



110530
(OE 42555041)
droit - right - rechts

09/2012 ->



110550
(OE 5801572024)
gauche - left - links



110560
(OE 5801572018)
droit - right - rechts



001619

EUROSTAR - EUROTECH - EUROTRAKKER

LC7

 p.166

1996 -> 2002



168610
(OE 99463244)   
gauche - left - links



IVECO
arrière
rear connector
Anschlusstecker hinten



168600
(OE 99463242)  
droit - right - rechts



067500
(OE 93161844) 
gauche - left - links





067500
(OE 93161844) 
droit - right - rechts

FPL93

 p.200



193020
(OE 500308514) 



001726
(OE 1608352)



D13876 

MASSIF 4 X 4

LC5

 p.161

2002 ->



152180
(OE 791123) 
gauche - left - links



arrière
rear connector
Anschlusstecker hinten



152180
(OE 791123) 
droit - right - rechts



D11868 



052500
(OE A610067-002) 
gauche - left - links



052500
(OE A610067-002) 
droit - right - rechts

06/2006 ->



D12334
(OE 69500032)
gauche - left - links





AMP 1.5-6P-M
arrière
rear connector
Anschlusstecker hinten



D12335
(OE 69500026)
droit - right - rechts





D11868 **AMP 1.5-7P-F**



D12336
(OE 42555132)
gauche - left - links





D12337
(OE 42555131)
droit - right - rechts



725V

06/2006 ->



D12338
(OE 69500591)

3.5T 

D12340
(OE 69500047)

5T 

gauche - left - links



D12339
(OE 69500590)

3.5T 

D12341
(OE 69500044)

5T 

droit - right - rechts

1999 -> 06/2006



D11482
(OE 500356783)
gauche - left - links





AMP 1.5-5P-M
arrière
rear connector
Anschlusstecker hinten



D11481
(OE 500356782)
droit - right - rechts





D11868 **AMP 1.5-7P-F**



D11480
gauche - left - links





D11479
droit - right - rechts



DAILY

LC7

 p.167

1996 -> 1999



168590
(OE 99463243)
gauche - left - links



IVECO
arrière
rear connector
Anschlussstecker hinten



168600
(OE 99463242)
droit - right - rechts



067500
(OE 93161844)
gauche - left - links





067500
(OE 93161844)
droit - right - rechts



725

 p.173



725040
gauche - left - links



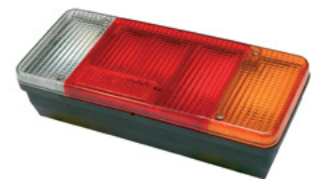

725010
droit - right - rechts





725002
gauche - left - links



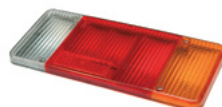

725012
droit - right - rechts



FPL93

 p. 200

1996 ->



193020
(OE 500308514)

K

JPT-2P-M



001726
(OE 1608352)



D13876 **JPT-2P-F**



193290
(OE 504097923)

K

SS-2P-M



D13880 **SS-2P-F**

FE94

 p. 204

1999 ->



198060
(OE 500341613)

JPT-2P-M



D13876 **JPT-2P-F**



001586

SEDDON EUROMOVER

LC7

 p.167

1996 -> 1999



168590
(OE 99463243)
gauche - left - links



IVECO
arrière
rear connector
Anschlussstecker hinten



168600
(OE 99463242)
droit - right - rechts



067500
(OE 93161844)
gauche - left - links





067500
(OE 93161844)
droit - right - rechts



ICDL94

 p.187



119550
(OE 97163920)





001616
(OE 5001834568)



D13877 

ICDL94

 p. 187



119550
(OE 5001020257)

JPT-3P-M



001616
(OE 5001834568)



D13877

JPT-3P-F



001626
(OE 5001837993)

FE95

 p. 193



195030
(OE 5001834505)



195060
(OE 5001834576)

SMD98

 p. 197

LED

 24V



198650
(OE 504217797)



JPT-2P-M



D13876

JPT-2P-F

URBAN WAY

ICDL94

i | p. 187



119550
(OE 5001020257)

JPT-3P-M



001616
(OE 5001834568)



D13877

JPT-3P-F



001626
(OE 5001837993)

SMD98

i | p. 197

LED

⚡ 24V



198650
(OE 504217797)

K

JPT-2P-M



D13876

JPT-2P-F

R312 - R332

LC6

i | p. 170



166500

K



066500

K

IVECO BUS

R312 - R332

LC7

 p. 166



167150
(OE 5010179915)



067000

FE81

 p. 212



181000
(OE 5000461058)



181050
(OE 5000461059)

AGORA - CITELIS

LC7

p. 166



167150
(OE 5010179915)



067000

ICDL94

 p. 187



119550
(OE 5001020257)

JPT-3P-M



001616
(OE 5001834568)



D13877

JPT-3P-F



001626
(OE 5001837993)

AGORA - CITELIS

SMD98

 p.197

LED

 24V



198650
(OE 504217797) 
JPT-2P-M



D13876 **JPT-2P-F**

FPL93

 p.200



193020
(OE 5010306792) 
JPT-2P-M



001726
(OE 5001847589)



D13876 **JPT-2P-F**

FE85

 p.194



185020
(OE 5010217022)



185050
(OE 5010104837)

FE95

 p.193



195030
(OE 5001834505)



195060
(OE 5001834576)

2751

 p.181



D14517 C5W

FPL93

 p. 200



193020
(OE 5010306792)

K

JPT-2P-M



001726
(OE 5001847589)



D13876 **JPT-2P-F**

FE81

 p. 212



181000
(OE 5000461058)



181050
(OE 5000461059)

BD95



195000
(OE 5010286898)



001606
(OE 5001834564)

FE95

 p. 193



195030
(OE 5001834505)



195060
(OE 5001834576)

ARES / ILIADE

ICDL94

 p. 187



119550
(OE 5001020257)

JPT-3P-M



001616
(OE 5001834568)



D13877

JPT-3P-F



001626
(OE 5001837993)

FPL93

 p. 200



193020
(OE 5010306792)

K

JPT-2P-M



001726
(OE 5001847589)



D13876

JPT-2P-F

FR1

FM91



191170 - P21W
(OE 5010197259)

Feu de recul
Reverse lamp
Rückfahrleuchte



191140 - P21W
(OE 5010197261)

Feu de position
Position lamp
Schlussleuchte



191120 - P21W
(OE 5010197262)

Feu stop
Stop lamp
Bremsleuchte



191150 - P21W
(OE 50101972564)

Feu clignotant arrière
Reverse flasher lamp
Hintere Blinkleuchte



191110 - P21W
(OE 5010197260)

Feu de brouillard
Fog lamp
Nebelschlussleuchte

PEGASUS p.254

LED

 10/30V



D14725
(OE W20TS01684)



GALAXY p.260

LED

 10/30V



D14749
(OE W20TS01401)



D14513
(OE W20TS00777)

LC12T LED

 p. 138

LED

 24V



161000

gauche - left - links



AMP 1.5-7P-M
arrière
rear connector
Anschlusstecker hinten



161010

droit - right - rechts



D11868 AMP 1.5-7P-F



D11689 AMP 1.5-7P

LC12 LED

 p. 138

LED

 24V



161260

gauche - left - links



AMP 1.5-7P-M
arrière
rear connector
Anschlusstecker hinten



161270

droit - right - rechts



D11868 AMP 1.5-7P-F



D11689 AMP 1.5-7P

LC8T

 p. 157



156040

gauche - left - links



AMP 1.5-7P-M
arrière
rear connector
Anschlusstecker hinten



156050

droit - right - rechts



D11868 AMP 1.5-7P-F



056700

gauche - left - links



056710

droit - right - rechts



D11689 AMP 1.5-7P

LAMBERET

LC8

 p.154



156310

gauche - left - links



AMP 1.5-7P-M

arrière
rear connector
Anschlusstecker hinten

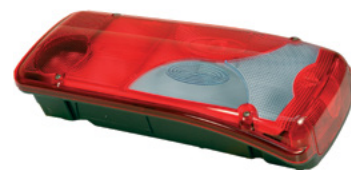

156300

droit - right - rechts



D11868

AMP 1.5-7P-F



056500

gauche - left - links



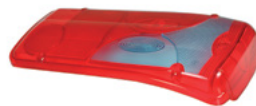

056510

droit - right - rechts





D11689

AMP 1.5-7P

LC5T

 p.164



153000

gauche - left - links





AMP 1.5-7P-M

arrière
rear connector
Anschlusstecker hinten



153010

droit - right - rechts





D11868

AMP 1.5-7P-F

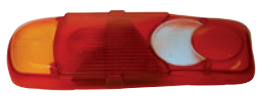

053700

gauche - left - links





053710

droit - right - rechts



LPL18

 p.179

LED



12/24V

NEW



199040

SS-2P-M



D13880

SS-2P-F

EPP96 LED

 p. 180

LED

 24V



D13874 2000 mm

POS-2P-F

EPP96

 p. 181



196020



D10227 700 mm

POS-2P-F

FE04

 p. 202

LED

 24V



104330 500 mm

SMD04

 p. 196

LED

 24V



104130 500 mm 

CLICK-IN



104090 500 mm 

104100 1500 mm 

CLICK-IN



104170 500 mm 

CLICK-IN



D14214

POS-2P-M

LAMBERET

SMD98 p.197

LED

 24V



D10496 1500 mm 

CLICK-IN



001716

FA3 LED p.207

LED

 12/24V



D13875 1000 mm

SL 1000 p.219

LED

 12/24V

 R23

NEW



D14880

RCL 1200 p.250

LED

 9/30V

 1200 Lumen

NEW



300010

NEW



300000

chromé - chrome-plated - verchromt

MDJ p.306



175020

BL15-CTL15

 p. 145

LED

 24V



Exemple de montage - Assembly suggestion - Montagebeispiel

NEW



164050
(OE 661058)



DTM04-4P-M

NEW



DT04-4P-M



DTM04-4P-M



164010

Pour raccordement sur feu BL15
To plug in BL15 lamp
Zum direkten Anschluss an die leuchte BL15

NEW



165020
gauche - left - links



DT04-4P-M



DTM06-4S-4P-F

NEW



165030
droit - right - rechts



D14436 **DT06-4S-4P-F**



D14437 **DTM06-4S-4P-F**



D14435 **DTM04-4P-M**

FCA

 p. 307



D11689 **AMP 1.5-7P**

LC8T p. 157



156250

gauche - left - links



AMP 1.5-7P-M

arrière
rear connector
Anschlusstecker hinten



156260

droit - right - rechts



156380

gauche - left - links



156390

droit - right - rechts



D11868

AMP 1.5-7P-F



056720

gauche - left - links



056730

droit - right - rechts



LC5T p. 164



153000

gauche - left - links



AMP 1.5-7P-M

arrière
rear connector
Anschlusstecker hinten



153010

droit - right - rechts



153130

droit - right - rechts



D11868

AMP 1.5-7P-F



053700

gauche - left - links



053710

droit - right - rechts



LC12T LED

 p. 138

LED

 24V



161000

gauche - left - links



AMP 1.5-7P-M
arrière
rear connector
Anschlusstecker hinten



161010

droit - right - rechts



D11868 **AMP 1.5-7P-F**



D11689 **AMP 1.5-7P**

SMD04

 p. 196

LED

 24V



104140

1500 mm 

CLICK-IN



104100

1500 mm 

CLICK-IN



104250

500 mm 

CLICK-IN

FPL93

 p. 193



193200



JPT-2P-M



001726



D13876

JPT-2P-F

SMD98

 p. 197

LED

 24V



D10494

500 mm 



001786

500 mm 

LINDE

SL 1000

 p. 222

LED

 12/24V

 1000 Lumen



D14970

DT-2P-M



D14170

DT-2P-F

QL LED

 p. 239

LED

 12/24V-100V



D14769



D14770



D14771



DT-2P-M



D14170

DT-2P-F

FRESNEL

 p. 259

LED

 10/110V



D14746



LC12 LED



p. 138

LED

24V



161000



gauche - left - links



AMP 1.5-7P-M

arrière
rear connector
Anschlussstecker hinten



161010



droit - right - rechts



D11868

AMP 1.5-7P-F



D14781

SS-2P-F

gauche - left - links



D14782

SS-2P-F

droit - right - rechts

SL 1000



p. 219

LED

12/24V

R23



D14857

DT-2P-M

Feu homologué recul - Homologated reverse lamp -
Genehmigt Rückfahrleuchte



D14170

DT-2P-F

04/2017 ->
12V



155550
(OE 65.25225-6004 / 7CE 945 095)
gauche - left - links



AMP 1.5-7P-M
arrière
rear connector
Anschlusstecker hinten



155560
(OE 65.25225-6005 / 7CE 945 096)
droit - right - rechts



TGA - TGL - TGM - TGX

2005 ->



156200
(OE 8125225-6544)
gauche - left - links



AMP 1.5-7P-M
latéral
side connector
Anschlusstecker seitlich

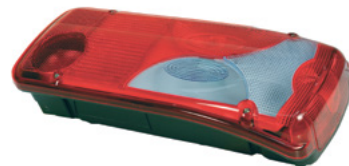

156210
(OE 8125225-6545)
droit - right - rechts



156220
(OE 8125225-6547)
droit - right - rechts



D11868 AMP 1.5-7P-F



056500
(OE 8125229-6059 / 65.25229.0000 / 7CE 945 111)



gauche - left - links

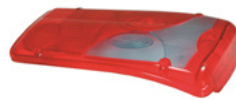

056510
(OE 8125229-6060 / 65.25229.001 / 7CE 945 112)



droit - right - rechts



001830 90 Db

001872 55-90 Db



10/110V

03/2018 ->



212020
(OE 81.25207-6074)
POS-2P-M



212030
(OE 81.25207-6075)
POS-2P-M



D13879 POS-2P-F

L - M - F

LC7

 p. 166

1990 -> 2004



168090
(OE 8125225-6033)  
gauche - left - links



DIN 72480-8P-M
arrière
rear connector
Anschlusstecker hinten



168090
(OE 8125225-6464)  
droit - right - rechts



168100
(OE 8125225-6034)   
gauche - left - links



168490
(OE 8125225-6528)   
droit - right - rechts



067500
(OE 8125229-6051) 
gauche - left - links



067500
(OE 8125229-6051) 
droit - right - rechts

TGA

LC7

 p. 166

1999 -> 2005



169180
(OE 8125225-6526)  
gauche - left - links



AMP 1.5-7P-M
latéral
side connector
Anschlusstecker seitlich



169170
(OE 8125225-6523)  
droit - right - rechts



169160
(OE 8125225-6524)   
gauche - left - links



169190
(OE 8125225-6530)   
droit - right - rechts



D11868 **AMP 1.5-7P-F**



067500
(OE 8125229-6051) 
gauche - left - links



067500
(OE 8125229-6051) 
droit - right - rechts



166700
(OE 8125225-6469)



gauche - left - links



PE
arrière
rear connector
Anschlussstecker hinten



166700
(OE 8125225-6470)



droit - right - rechts



066500



gauche - left - links



066500



droit - right - rechts

MANISCOPIC

LC5

 p. 161

2001 ->



152180
(OE 661973 / 223767)

gauche - left - links





AMP 1.5-7P-M

arrière
rear connector
Anschlusstecker hinten



152180
(OE 661973 / 223766)

droit - right - rechts





D11868 **AMP 1.5-7P-F**



052500
(OE 661973)

gauche - left - links





052500
(OE 661973)

droit - right - rechts



MSI

BBS516

 p. 175

1999 ->



500930
(OE 163782)

gauche - left - links



PF
arrière
rear connector
Anschlusstecker hinten



500940
(OE 163783)

droit - right - rechts

2751

 p. 181



D14517
(OE 227330)

CHL 1 LED

 p. 242

LED

 12/24V



D14380
(OE 959694 / 52562043)

gauche - left - links



DT-6P-M
arrière
rear connector
Anschlusstecker hinten



D14381
(OE 959695 / 52562044)

droit - right - rechts



D14352 **DT-6P-F**

LED

NEW



9/32V



212520





GROVE

LC8

 p. 152



156860
(OE 03137250)   

gauche - left - links



AMP 1.5-7P-M

arrière
rear connector
Anschlusstecker hinten



156870
(OE 03137251)  

droit - right - rechts



D11868 **AMP 1.5-7P-F**



056540 

gauche - left - links



056550 

droit - right - rechts





001830
(OE 03137254) 

LC5

 p. 161



152170
(OE 03320939)  

gauche - left - links



AMP 1.5-7P-M

arrière
rear connector
Anschlusstecker hinten



152180
(OE 03320938) 

droit - right - rechts



D11868 **AMP 1.5-7P-F**



052500 

gauche - left - links



052500 

droit - right - rechts

SMD98

 p. 197

LED

 24V



198660
(OE 03138527) 

JPT-2P-M



198520
(OE 03320937) 

JPT-2P-M



D10493
(OE 03329572) 500 mm 

CLICK-IN



198640
(OE 03329492) 

JPT-2P-M



D13876 **JPT-2P-F**

vignal-group.com



08/2020 ->

NEW

LED

 24V



212710
(OE A 960 820 02 58 / A 960 820 03 58)  



MQS-2P-M

ZETROS

09/2019 ->

NEW



155590
(OE A 959 544 01 03)   

gauche - left - links





AMP 1.5-7P-M

arrière
rear connector
Anschlusstecker hinten

NEW





155600
(OE A 959 544 02 03)  

droit - right - rechts

NEW



155610
(OE A 959 544 03 03)   

droit - right - rechts



D11868 **AMP 1.5-7P-F**



056540
(OE A 000 826 20 56) 

gauche - left - links



056550
(OE A 000826 21 56) 

droit - right - rechts



001830
Alarme sonore de recul
Back up alarm
Rückfahrsignalhorn

SPRINTER

LC11



 p. 141

03/2018 ->

LED

 12V





160400
(OE A 910 820 64 00)   

gauche - left - links



AMP 1.5-7P-M
arrière
rear connector
Anschlussstecker hinten



160410
(OE A 910 820 65 00)  

droit - right - rechts



D11868 **AMP 1.5-7P-F**



060000
(OE A 910 826 10 00) 

gauche - left - links



060010
(OE A 910 826 11 00) 



droit - right - rechts

LC8

 p. 156

06/2006 ->





156340
(OE A 906 820 04 64)   

gauche - left - links



AMP 1.5-7P-M
arrière
rear connector
Anschlussstecker hinten



156350
(OE A 906 820 17 64)  

droit - right - rechts



D11868 **AMP 1.5-7P-F**



056540
(OE A 000 826 20 56) 

gauche - left - links



056550
(OE A 000 826 21 56) 

droit - right - rechts

ATLAS



 p. 252

03/2018 ->

LED



 9/32V



212010
(OE A 910 906 29 00 / A 910 906 64 00)  

KOSTAL-2P-M



212420
(OE A 910 906 69 00)  

SMD98

 p. 197

04/2019->

 LED

 24V

NEW



198760
(OE A 956 544 00 11)

 K

SS-2P-M



D13880

SS-2P-F

FE08 H1

04/2019->

 LED

 24V

NEW



116200
(OE A 956 820 00 59)

SONDERFAHRZEUG

EPP96

 p. 181

06/2012 -> Lowliner



196170
(OE A 949 540 01 04) 500 mm

HDSCS-3P-M

VEGA LED

 p. 256

LED

 10/30V



D14508
(OE 116119)



D14513
(OE 115856)

VEGA

 p. 261

 H1 -12/24V



D14479
(OE 115855)



D14513
(OE 115856)

LPL18

 p. 179

LED

NEW



12/24V

08/2020 ->



199000
(OE 47363002)

SS-2P-M



D13880

SS-2P-F

SMD98

 p. 197

LED



12V

08/2018->



198810
(OE 5141966)

K

SS-2P-M



D13880

SS-2P-F

RH3

 p. 236



H3/70W
12V

08/2018 ->



D14654
(OE 51431987)

DT-2P-M



D14170

DT-2P-F

FT

 p. 234

LED



12/24V

07/2017 ->



D14191
(OE 47826594)



D14192

NT400 - CABSTAR - ATLEON

LC5

 p. 161



152170
(OE 26555-9X126)

gauche - left - links



AMP 1.5-7P-M

arrière
rear connector
Anschlussstecker hinten



152180
(OE 26555-9X125)

droit - right - rechts





153120
(OE 26555-9X128)

droit - right - rechts



D11868 **AMP 1.5-7P-F**



052500
(OE 26554-9X126)

gauche - left - links





052500
(OE 26554-9X126)

droit - right - rechts



ICDL94

 p. 187



119550
(OE 26164-9X402)

JPT-3P-M



001616
(OE 26244-9X400)



D13877 **JPT-3P-F**

OMEPS

LC12 LED p. 138

LED

 24V



161280

gauche - left - links



AMP 1.5-7P-M

arrière
rear connector
Anschlussstecker hinten



161290

droit - right - rechts



D11868

AMP 1.5-7P-F



D14781

gauche - left - links



D14782

droit - right - rechts



SS-2P-F

EPP96 LED p. 180

LED

 12/24V



R14364

SS-2P-M

SMD04 p. 196

LED

 12/24V



104690

K

SS-2P-M



104670

K

SS-2P-M



D13880

SS-2P-F

CARBONLUX

 p. 220

LED

NEW

 10/30V

 R23



D14811

DT-2P-M



Interrupteur - switch - Schalter



D14170

DT-2P-F

5054

 p. 292



Max 6 kg

D14538

LC5

 p. 161

04/2010 ->



152180
(OE 4421265)

gauche - left - links





AMP 1.5-7P-M

arrière
rear connector
Anschlussstecker hinten



152180
(OE 4421266)

droit - right - rechts





D11868

AMP 1.5-7P-F



052500

gauche - left - links





052500

droit - right - rechts



EPP98

 p. 181

04/2010 ->



196010
(OE 4421269)

JPT-2P-M



D13876

JPT-2P-F

07/2012 ->



Fixation 4 vis M6 (190x60mm)
 Fixing 4 screws M6 (190x60mm)
 Befestigung 4 Schrauben M6
 (190x60mm)



153270 
 (OE 6350FS / 9815127080)

gauche - left - links



AMP 1.5-7P-M
 arrière
 rear connector
 Anschlussstecker hinten



153280 
 (OE 6351FS / 9815126980)

droit - right - rechts



D11868 **AMP 1.5-7P-F**



052500 

gauche - left - links



052500 

droit - right - rechts

RENAULT TRUCKS

EURO 6 - T / K / C

LC9 LED

 p. 142



EURO 6

LED

 24V

12/2017->





158030
(OE 7425982261 / 7422800385 / 7484585208)   

gauche - left - links





AMP 1.5-7P-M
latéral
side connector
Anschlussstecker seitlich



158050
(OE 7425982262 / 7423080010 / 7484585206)  

droit - right - rechts



158040
(OE 7425982262 / 7422800386 / 7484585204)   

droit - right - rechts



D11868 **AMP 1.5-7P-F**



058000
(OE 7422800391) 

gauche - left - links



058000
(OE 7422800391) 

droit - right - rechts

ATLAS

 p. 252

LED

 9/32V

09/2021->

NEW



212740
(OE 23811106)  **AMP-4P-F**

NEW



212750
(OE 23811107)  **AMP-4P-F**

TRI

 p. 217



D10596
(OE 7423374865)

EURO 6 - T / K / C --> 520 CH

LC9 ⓘ p. 160

EURO 6

11/2013 ->



159010
(OE 7420802348) K FPL EPP
gauche - left - links



AMP 1.5-7P-M
latéral
side connector
Anschlusstecker seitlich



159020
(OE 7420802350) K FPL
droit - right - rechts



159030
(OE 7420802353) K FPL LED
droit - right - rechts



D11868 **AMP 1.5-7P-F**



059000
(OE 7420802418) K
gauche - left - links



059000
(OE 7420802418) K
droit - right - rechts



D12953 LED

LC10 LED ⓘ p. 143

EURO 6

LED

24V

09/2020->



Entraxe : 152 mm
Bolt distance : 152 mm
Schraubenabstand : 152 mm

NEW



159500
(OE 7423530440) K FPL EPP
gauche - left - links



AMP 1.5-7P-M
latéral
side connector
Anschlusstecker seitlich

NEW



159530
(OE 7423530442) K FPL
droit - right - rechts

NEW



159520
(OE 7423530438) K FPL
gauche - left - links

NEW



159510
(OE 7423530441) K LED
droit - right - rechts



D11868 **AMP 1.5-7P-F**



059500
(OE 7423292490) K
gauche - left - links



059500
(OE 7423292490) K
droit - right - rechts

RENAULT TRUCKS

EURO 6 - T / K / C --> 520 CH

FE09

EURO6

11/2013 ->



115020
(OE 7482346591)
gauche - left - links



115020
(OE 7482346591)
droit - right - rechts



115000
(OE 7482252506)
gauche - left - links



115010
(OE 7482367030)
droit - right - rechts



115040
(OE 7482252291)



115030
(OE 7482255014)

SL08

EURO6

11/2013 ->



113020
(OE 7482266219) 10W
Lampe de portière
Door lamp
Türleuchte



113030
(OE 7482285707) 5W
Feu d'embarquement
Step lamp
Einstiegsbeleuchtung

SMD00

 p. 198

EURO6

LED

 24V

12/2013->



198620
(OE 7482392733) 
Cuve blanche - cabochon PMMA
White body - PMMA lens
Weißes Gehäuse - PMMA Lichtscheibe



198740
(OE 7482586940) 
Cuve ambre - cabochon PC haute température
Amber body - PC lens high temperature
Oranges Gehäuse - PC Lichtscheibe hoch temperatur beständig

EURO 6 - T / K / C --> 520 CH

SHD 1200

 p. 227

EURO 6

LED

 9/36V

07/2014 ->



D14161
(OE 7484185589)

DT-2P-M



D14170

DT-2P-F

SH3

 p. 237

EURO 6

11/2013 ->



* Lampe fournie

* Bulb included

* Inklusiv Glühlampen



D13019 *
(OE 7421396991)

DT-2P-M



D14170

DT-2P-F

MAGNUM

LC9

 p. 160

01/2006 ->



159010
(OE 7420802348)

gauche - left - links



AMP 1.5-7P-M

latéral
side connector
Anschlusstecker seitlich



159020
(OE 7420802350)

droit - right - rechts



159030
(OE 7420802353)

droit - right - rechts



D11868 AMP 1.5-7P-F



059000
(OE 7420802418)

gauche - left - links





059000
(OE 7420802418)

droit - right - rechts





D12953



09/2004 -> 01/2006



169310
(OE 5001864535)

gauche - left - links



AMP 1.5-7P-M

latéral
side connector
Anschlussstecker seitlich

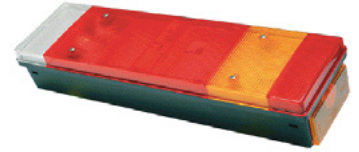

169320
(OE 5001864536)

droit - right - rechts



Entraxe : 160 mm
Bolt distance : 160 mm
Schraubenabstand : 160 mm

12/1998 -> 09/2004



169020
(OE 5001847586)

gauche - left - links



AMP 1.5-7P-M

latéral
side connector
Anschlussstecker seitlich



169030
(OE 5001847587)

droit - right - rechts



169000
(OE 5001847584)

gauche - left - links



169010
(OE 5001847585)

droit - right - rechts



D11868

AMP 1.5-7P-F



067000
(OE 5000296594)

067500
(OE 5001847588)

gauche - left - links



067000
(OE 5000296594)

067500
(OE 5001847588)

droit - right - rechts



D12953



MAGNUM

LC7

 p. 166

1990 -> 1994



167100
(OE 5000296592)

gauche - left - links



PE
arrière
rear connector
Anschlussstecker hinten



167000
(OE 5000296592)

droit - right - rechts

1994 -> 12/1998



168220
(OE 5001831194)

gauche - left - links



168260
(OE 5001832999)

droit - right - rechts



067000
(OE 5000296594)

067500
(OE 5001847588)

gauche - left - links



067000
(OE 5000296594)

067500
(OE 5001847588)

droit - right - rechts



LC6

 p. 170

1991 -> 12/1998



166100 *
(OE 5000296591)

gauche - left - links



PE
arrière
rear connector
Anschlussstecker hinten



166000 *
(OE 5000296591)

droit - right - rechts

12/1998 -> 09/2004



169060
(OE 5001847582)

gauche - left - links



AMP 1.5-7P-M
latéral
side connector
Anschlussstecker seitlich



169070
(5001847583)

droit - right - rechts



D11868 AMP 1.5-7P-F



066000
(OE 5000296593)

gauche - left - links



066000
(OE 5000296593)

droit - right - rechts

RENAULT TRUCKS

MAGNUM

FE85

 p. 194

1991 ->



185020
(OE 5010217022)
gauche - left - links



185020
(OE 5010217022)
droit - right - rechts

1991 -> 12/1998



185040
(OE 5010217023) 5W
gauche - left - links



185040
(OE 5010217023) 5W
droit - right - rechts

12/1998 ->



185160
(OE 5010271807) 21W
gauche - left - links



185160
(OE 5010271807) 21W
droit - right - rechts

FE04

 p. 190

LED

 24V

06/2008 ->



104570
(OE 7421430181/7482562006)

DT-2P-M



104450
(OE 7421137718)

DT-2P-M



D14170

DT-2P-F

FPL93

 p. 200

1994 ->



193020
(OE 5010306792 / 7484538758) 

JPT-2P-M



001726
(OE 5001847589)



D13876

JPT-2P-F

MAGNUM

FE02

 p. 193

2003 ->



102200
(OE 5001862030) 
Clippé - clipped - clip-befestigung
JPT-2P-M



001726
(OE 5001847589)



D13876 **JPT-2P-F**

SH3

 p. 237

10/2009 ->



- * Lampe fournie
- * Bulb included
- * Inklusiv Glühlampen



D13019 *
(OE 7421396991)
DT-2P-M



D14170 **DT-2P-F**

PREMIUM / KERAX / EURO 6 - C --> 320 CH

LC9

 p. 160

EURO 6

01/2006 ->



159010
(OE 7420802348)   
gauche - left - links



AMP 1.5-7P-M
latéral
side connector
Anschlusstecker seitlich



159020
(OE 7420802350)  
droit - right - rechts



159030
(OE 7420802353)   
droit - right - rechts



D11868 **AMP 1.5-7P-F**



059000
(OE 7420802418) 
gauche - left - links



059000
(OE 7420802418) 
droit - right - rechts



D12953 

Premium
09/2004 -> 01/2006
Kerax
09/2004 -> 09/2006



Entraxe : 160 mm
Bolt distance : 160 mm
Schraubenabstand : 160 mm



169310
(OE 5001864535)



gauche - left - links



AMP 1.5-7P-M

latéral
side connector
Anschlussstecker seitlich



169320
(OE 5001864536)



droit - right - rechts



D11868

AMP 1.5-7P-F



067500
(OE 5001847588)



gauche - left - links



067500
(OE 5001847588)



droit - right - rechts

Premium
1999 -> 09/2004



169020
(OE 5001847586)



gauche - left - links



AMP 1.5-7P-M

latéral
side connector
Anschlussstecker seitlich

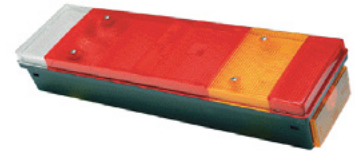

169030
(OE 5001847587)



droit - right - rechts

Premium
1999 -> 09/2004
Kerax
09/1998 -> 09/2004



169000
(OE 5001847584)



gauche - left - links

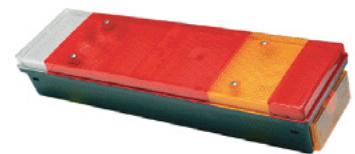

169010
(OE 5001847585)



droit - right - rechts



D11868

AMP 1.5-7P-F



067000
(OE 5000296594)

067500
(OE 5001847588)



gauche - left - links



067000
(OE 5000296594)

067500
(OE 5001847588)



droit - right - rechts



D12953





PREMIUM / KERAX

LC7

 p. 166

Premium
1995 -> 1999
Kerax
1995 -> 09/1998



168220
(OE 5001831194)  

 **168260**
(OE 5001832999) 
gauche - left - links



PE
arrière
rear connector
Anschlusstecker hinten



168260
(OE 5001832999) 

 **168140**
(OE 5001835853)  
droit - right - rechts



067000
(OE 5000296594)
gauche - left - links



067000
(OE 5000296594)
droit - right - rechts

LC5

Premium
06/2001 -> 09/2004



152020 *
(OE 5001846847) 

 **152510 ****
(OE 5001857964) 
gauche - left - links



AMP 1.5-7P-M
arrière
rear connector
Anschlusstecker hinten



152500 **
(OE 5001858092)

 **152520 ***
(OE 5001857965)
droit - right - rechts

* pas de fonction recul
* no reverse function
* ohne Rückfahrchein werfer
** pas de fonction brouillard
** no fog function
** ohne Nebelschlussleuchte



D11868 AMP 1.5-7P-F



052000
(OE 5010392231)
gauche - left - links



052000
(OE 5010392231)
droit - right - rechts

RENAULT TRUCKS

PREMIUM / KERAX

LC6

 p. 170

Premium
12/1998 -> 09/2004



169060
(OE 5001847582)

gauche - left - links



AMP 1.5-7P-M

latéral
side connector
Anschlussstecker seitlich



169070
(OE 5001847583)

droit - right - rechts

* Silent blocs non fournis,
voir réf. 001706 p. 170

*Silent blocs not supplied,
see p/n 001706 p. 170

* Schwingungsdämpfer Art.-Nr.
001706 nicht im Lieferumfang, s.
Seite p. 170

Premium
1995 -> 12/1998



166100 *
(OE 5000296591)

gauche - left - links



PE
arrière
rear connector
Anschlussstecker hinten



166000 *
(OE 5000296591)

droit - right - rechts

Kerax
1995 -> 09/1998



D11868 **AMP 1.5-7P-F**



066000
(OE 5000296593)

gauche - left - links



066000
(OE 5000296593)

droit - right - rechts

PREMIUM / KERAX / EURO 6 - C --> 320 CH

FE95

 p. 193

EURO6

1995 ->



195010
(OE 5001834561)

gauche - left - links



195010
(OE 5001834561)

droit - right - rechts

PREMIUM / KERAX / EURO 6 - C --> 320 CH

ICDL94



p. 187

EURO 6

1995 ->



119450
(OE 5001834565)

5W

JPT-3P-M



119470
(OE 5001847597)

21W

JPT-3P-M

Premium 12/1998 ->
Kerax 1999 ->



001616
(OE 5001834568)



D13877

JPT-3P-F

FE02



p. 193

EURO 6

2003 ->



102200
(OE 5001862030)

K

Clippé - clipped - clip-befestigung

JPT-2P-M



001726
(OE 5001847589)



D13876

JPT-2P-F

SMD98



p. 197

EURO 6

LED

24V

09/2007 ->



198650
(OE 7421106206)

K

Feu d'identification Viscope
Viscope identification lamp
Markierungsleuchte Viscope

JPT-2P-M



D13876

JPT-2P-F

RENAULT TRUCKS

PREMIUM / KERAX / EURO 6 - C --> 320 CH

FPL93

 p. 193

2003 ->



193200
(OE 5001862030)

Vissé - Screwed - Geschraubt

 **JPT-2P-M**

1995 ->



193020
(OE 5010306792)

 **JPT-2P-M**



001726
(OE 5001847589)



D13876 **JPT-2P-F**

SH3

 p. 237



24V

10/2009 ->



- * Lampe fournie
- * Bulb included
- * Inklusiv Glühlampen



D13019 *
(OE 7421396991)

DT-2P-M



D14170 **DT-2P-F**

MIDLINER

LC4

 p. 171



141500
(OE 5000808172)

gauche - left - links



PE
arrière
rear connector
Anschlussstecker hinten



141500
(OE 5000808172)

droit - right - rechts



040500
(OE 5000808166)

gauche - left - links





040500
(OE 5000808166)

droit - right - rechts



EURO 6 - D --> 18 T

LC10 LED  p. 143

EURO6

LED

 24V

09/2020->

 Entraxe : 152 mm
Bolt distance : 152 mm
Schraubenabstand : 152 mm

NEW



159500
(OE 7423530440)   
gauche - left - links



AMP 1.5-7P-M
latéral
side connector
Anschlusstecker seitlich

NEW



159530
(OE 7423530442)  
droit - right - rechts

NEW



159520
(OE 7423530438)  
gauche - left - links

NEW



159510
(OE 7423530441)   
droit - right - rechts



D11868 **AMP 1.5-7P-F**



059500
(OE 7423292490) 
gauche - left - links



059500
(OE 7423292490) 
droit - right - rechts

LC5

 p. 161

EURO6

09/2021->

NEW



152170
(OE 5010595381)  
gauche - left - links



AMP 1.5-7P-M
arrière
rear connector
Anschlusstecker hinten

NEW



152180
(OE 5010595382) 
droit - right - rechts



D11868 **AMP 1.5-7P-F**



052500
(OE 5001847153) 
gauche - left - links



052500
(OE 5001847153) 
droit - right - rechts

RENAULT TRUCKS

MIDLUM / EURO 6 - D --> 18 T

LC7

 p. 166

1999 -> 04/2006



169000
(OE 5001847584)
gauche - left - links



AMP 1.5-7P-M
latéral
side connector
Anschlussstecker seitlich



169010
(OE 5001847585)
droit - right - rechts



D11868 **AMP 1.5-7P-F**



067500
(OE 5001847588)
gauche - left - links





067500
(OE 5001847588)
droit - right - rechts



LC5

 p. 163

EURO 6

09/2005 ->

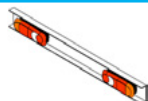

152880
(OE 7420862032)
gauche - left - links





AMP 1.5-7P-M
arrière
rear connector
Anschlussstecker hinten



152880
(OE 7420862035)
droit - right - rechts



1999 -> 09/2005



* pas de fonction recul
* no reverse function
* ohne Rückfahrchein werfer

** pas de fonction brouillard
** no fog function
** ohne Nebelschlussleuchte



152000 *
(OE 5001846843)





152040 **
(OE 5001846845)



gauche - left - links



152010 **
(OE 5001846844)





152050 *
(OE 5001846846)



droit - right - rechts



D11868 **AMP 1.5-7P-F**



052500
(OE 5001847153)
gauche - left - links





052500
(OE 5001847153)
droit - right - rechts



MIDLUM / EURO 6 - D --> 18 T

LC5

 p. 161

EURO 6

09/2005 ->



152190
(OE 7420862038)

gauche - left - links





AMP 1.5-7P-M
arrière
rear connector
Anschlussstecker hinten



152200
(OE 7420862041)

droit - right - rechts

1999 -> 09/2005



* pas de fonction recul
* no reverse function
* ohne Rückfahrchein werfer

** pas de fonction brouillard
** no fog function
** ohne Nebelschlussleuchte



152020 *
(OE 5001846847)





152060 **
(OE 5001846849)



gauche - left - links



152030 **
(OE 5001846848)



152070 *
(OE 5001846850)

droit - right - rechts



D11868 **AMP 1.5-7P-F**



052000
(OE 5010392231)
gauche - left - links



052000
(OE 5010392231)
droit - right - rechts

EPP96

 p. 181

1999 -> 2003



196020
(OE 7700353021)

EPP98

 p. 181

EURO 6

2003 ->



196010
(OE 5010293829)

JPT-2P-M



D13876 **JPT-2P-F**

RENAULT TRUCKS

MIDLUM / EURO 6 - D --> 18 T

FM91

08/2008 ->



191170
(OE 7421268609)

ICDL94



p. 187

EURO 6

-> 1999

1999 ->



119450
(OE 5001834565)

5W

JPT-3P-M



119470
(OE 5001847597)

21W

JPT-3P-M



001616
(OE 5001834568)



D13877

JPT-3P-F

FE95



p. 193

EURO 6

1999 ->



195010
(OE 5001834561)
gauche - left - links



195010
(OE 5001834561)
droit - right - rechts

FE02



p. 193

EURO 6

2003 ->



102200
(OE 5001862030)

K

Clippé - clipped - clip-befestigung



001726
(OE 5001847589)



D13876

JPT-2P-F

JPT-2P-M

MIDLUM / EURO 6 - D --> 18 T

FPL93

 p. 200

1999 ->



193020
(OE 5010306792)



JPT-2P-M



193280
(OE 7420894265)



JPT-2P-M



001726
(OE 5001847589)



D13876 JPT-2P-F

MAXITY / EURO 6 - D --> 7,5 T

LC5

 p. 161

EURO6

2009 ->



152170
(OE 7485118470)
gauche - left - links







AMP 1.5-7P-M

arrière
rear connector
Anschlussstecker hinten



152180
(OE 5001870556)
droit - right - rechts





D11868 AMP 1.5-7P-F



052500
(OE 5001847153)
gauche - left - links





052500
(OE 5001847153)
droit - right - rechts



RENAULT TRUCKS

MASCOTT

LC5

EURO6

04/2006 ->

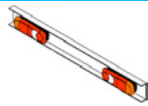

152880
(OE 7420862032)

gauche - left - links



AMP 1.5-7P-M
arrière
rear connector
Anschlusstecker hinten



152880
(OE 7420862035)

droit - right - rechts



07/2001 -> 04/2006

* pas de fonction recul
* no reverse function
* ohne Rückfahrchein werfer

** pas de fonction brouillard
** no fog function
** ohne Nebelschlussleuchte



152000 *
(OE 5001846843)

gauche - left - links



152600 **
(OE 5001858093)

droit - right - rechts



D11868 **AMP 1.5-7P-F**



052500
(OE 5001847153)

gauche - left - links



052500
(OE 5001847153)

droit - right - rechts



LC5

 p. 161

04/2006 ->



152170
gauche - left - links



AMP 1.5-7P-M
arrière
rear connector
Anschlusstecker hinten



152180
droit - right - rechts



D11868 **AMP 1.5-7P-F**



052500
(OE 5001847153)

gauche - left - links



052500
(OE 5001847153)

droit - right - rechts



MASCOTT

LC5

07/2001 -> 04/2006

* pas de fonction recul
* no reverse function
* ohne Ruckfahrtschein werfer

** pas de fonction brouillard
** no fog function
** ohne Nebelschlussleuchte



152020 *
(OE 5001846847) EPP

 **152510 ****
(OE 5001857964) EPP

gauche - left - links



AMP 1.5-7P-M

arrière
rear connector
Anschlusstecker hinten



152500 **
(OE 5001858092)

 **152520 ***
(OE 5001857965)

droit - right - rechts



D11868 AMP 1.5-7P-F



052000
(OE 5010392231)
gauche - left - links



052000
(OE 5010392231)
droit - right - rechts

LC4

 p.171

1998 -> 07/2001



141500
(OE 5000808172) K EPP
gauche - left - links



PE
arrière
rear connector
Anschlusstecker hinten



141500
(OE 5000808172) K EPP
droit - right - rechts



040500
(OE 5000808166) K
gauche - left - links



040500
(OE 5000808166) K
droit - right - rechts

EPP98

 p.181

1998 ->



196010
(OE 5010293829)

JPT-2P-M



D13876 JPT-2P-F

RENAULT TRUCKS

MASCOTT

ICDL94

 p. 187

1998 ->



119450
(OE 5001834565) 5W
JPT-3P-M



001616
(OE 5001834568)



D13877 **JPT-3P-F**

SMD98

 p.197

LED



4xLEDS - 12V

1998 ->



198510
(OE 7700377208) **K**
JPT-2P-M



D13876 **JPT-2P-F**

CA

 p. 216

1998 -> 04/2006



D14590
(OE 7700377130)

04/2006 ->

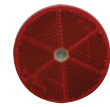

D14593
(OE 8200602314)

TRAFIC

LC5

 p. 161

10/2014 ->



152180
(OE 265551402R) **K**

152180
(OE 265550674R) **K** 

gauche - left - links



AMP 1.5-7P-M

arrière
rear connector
Anschlusstecker hinten



152180
(OE 265504514R) **K**

152180
(OE 265500292R) **K** 

droit - right - rechts



D11868 **AMP 1.5-7P-F**



052500
(OE 5001847153) **K**

gauche - left - links



052500
(OE 5001847153) **K**

droit - right - rechts

MASTER

LC5

 p. 161

04/2010 ->



152180
(OE 265551402R) 

AMP 1.5-7P-M
arrière
rear connector
Anschlusstecker hinten

152180
(OE 265504514R) 

152180
(OE 265550674R)  
gauche - left - links

 **152180**
(OE 265500292R) 
droit - right - rechts



D11868 AMP 1.5-7P-F



052500
(OE 5001847153) 
gauche - left - links



052500
(OE 5001847153) 
droit - right - rechts

EPP96

 p. 181

-> 04/2010



196020
(OE 7700353021)

EPP98

 p. 181

-> 04/2010



196010
(OE 265100848R)



D13876 JPT-2P-F

JPT-2P-M

SMD98

 p.197

LED

 4xLEDS - 12V

-> 04/2010



198580 
JPT-2P-M



D13876 JPT-2P-F

RENAULT TRUCKS

GAMME B

LC4

 p.171



141000
(OE 5000808171)

gauche - left - links





PE
arrière
rear connector
Anschlussstecker hinten



141000
(OE 5000808171)

droit - right - rechts





040000
(OE 5000807304)

gauche - left - links

040000
(OE 5000807304)

droit - right - rechts

FE85

 p.194



185020
(OE 5010217022)

gauche - left - links



185020
(OE 5010217022)

droit - right - rechts

FPL93

 p.200



193020
(OE 5010306792 / 7484538758)







001726
(OE 5001847589)



D13876 

GAMME C

LC4

 p.171

-> 1986



141500
(OE 5000808172)
gauche - left - links



PE
arrière
rear connector
Anschlussstecker hinten



141500
(OE 5000808172)
droit - right - rechts



040500
(OE 5000808166)
gauche - left - links





040500
(OE 5000808166)
droit - right - rechts



FE81

 p.212



181050
(OE 5000461059)



181000
(OE 5000461058)

FE88

 p.211



188310
(OE 5000623050)



088010
(OE 5000296718)

RENAULT TRUCKS

GAMME G

LC4

 p.171

-> 1986



141000
(OE 5000808171)



141500
(OE 5000808172)

gauche - left - links



PE
arrière
rear connector
Anschlussstecker hinten



141000
(OE 5000808171)



141500
(OE 5000808172)

droit - right - rechts



040000
(OE 5000807304)

040500
(OE 5000808166)

gauche - left - links



040000
(OE 5000807304)

040500
(OE 5000808166)

droit - right - rechts

LC6

 p.170

1986 ->



166000
(OE 5000296591)

gauche - left - links





PE
arrière
rear connector
Anschlussstecker hinten



166000
(OE 5000296591)

droit - right - rechts



066000
(OE 5000296593)

gauche - left - links



066000
(OE 5000296593)

droit - right - rechts

GAMME J

FE81

 p. 212



181050
(OE 5000461059)



181000
(OE 5000461058)

FE88

 p. 211



188310
(OE 5000623050)



088010
(OE 5000296718)

FPL93

 p. 200



193020
(OE 5010306792 / 7484538758) 

 JPT-2P-M



001726
(OE 5001847589)



D13876  JPT-2P-F

RENAULT TRUCKS

GAMME R

LC7

 p.166

1994 ->



167100
(OE 5000296592)
gauche - left - links





PE
arrière
rear connector
Anschlusstecker hinten



167000
(OE 5000296592)
droit - right - rechts



168220
(OE 5001831194)
gauche - left - links

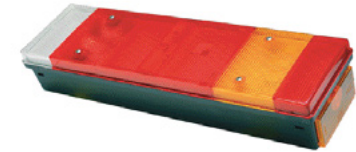

168260
(OE 5001832999)
droit - right - rechts



067000
(OE 5000296594)



067000
(OE 5000296594)

067500
(OE 5001847588)
gauche - left - links



067500
(OE 5001847588)
droit - right - rechts



LC4

 p.171

-> 1994



141000
(OE 5000808171)
gauche - left - links





PE
arrière
rear connector
Anschlusstecker hinten



141000
(OE 5000808171)
droit - right - rechts





040000
(OE 5000807304)
gauche - left - links





040000
(OE 5000807304)
droit - right - rechts

GAMME R

FPL93

 p. 200



193020
(OE 5010306792 / 7484538758) 



001726
(OE 5001847589)



D13876 

GAMME S

LC4

 p. 171



141000
(OE 5000808171) 
gauche - left - links



PE
arrière
rear connector
Anschlussstecker hinten



141000
(OE 5000808171) 
droit - right - rechts



040000
(OE 5000807304)
gauche - left - links



040000
(OE 5000807304)
droit - right - rechts

FE87

 p. 211



188310
(OE 5000623050)



088010
(OE 5000296718)

10/2020 ->

NEW

LED

 9/32V



212420



SERIE P&R

LC8

 p.155

08/2013 ->



155080
(OE 2160128)

gauche - left - links



AMP 1.5-7P-M

arrière
rear connector
Anschlusstecker hinten



155520
(OE 2340796)

droit - right - rechts



155090
(OE 2160127)

droit - right - rechts



01/2007 ->



156770
(OE 1756754/2021579/2129985)

gauche - left - links



AMP 1.5-7P-M

latéral
side connector
Anschlusstecker seitlich



156780
(OE 1756751/2021575/2129987)

droit - right - rechts



155020
(OE 2021578/2129986)

droit - right - rechts



156790
(OE 1791369/2021576/2129988)

droit - right - rechts



D11868 AMP 1.5-7P-F



056540
(OE 1784669/2129992)
gauche - left - links



056550
(OE 1784670/2129991)
droit - right - rechts



001830



LC7

 p. 168

1990 -> 1998



168350
(OE 1365963)   
gauche - left - links

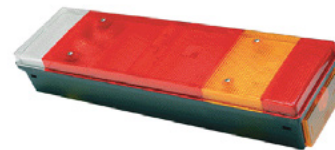

168360
(OE 1365964)  
droit - right - rechts



067500
(OE 1350343) 
gauche - left - links

067500
(OE 1350343) 
droit - right - rechts

SLA 2000

 p. 223

 LED

NEW



12/24V



2000 Lumen



D14852
(OE 2862201)





D14170 

SH3

 p. 237



- * Lampe fournie
- * Bulb included
- * Inklusiv Glühlampen

D13019 *
(OE 7421396991)



D14170 

TRI

 p. 217



D10596
(OE 2020496)

LC12 LED

 p. 138

LED

 24V

GLOWING



NEW



161280
(OE 1370066)
gauche - left - links



AMP 1.5-7P-M
arrière
rear connector
Anschlusstecker hinten

NEW



161290
(OE 1370067)
droit - right - rechts



D11868 **AMP 1.5-7P-F**

LC12 LED

 p. 138

LED

 24V

ORIGINAL



161000
(OE 1302341 / 1364736)
gauche - left - links



AMP 1.5-7P-M
arrière
rear connector
Anschlusstecker hinten



161010
(OE 1302342 / 1364737)
droit - right - rechts



D11868 **AMP 1.5-7P-F**

LCR19

 p. 146

LED

 24V

SMC
Position latéral clignotant
Side marker flashing lamp
Blinkende seiten markierungs-
leuchte

POS
Position
Schlußlicht

RI
Resistance intégrée (contrôle
défaillance indicateur)
Integrated resistance (indicator
failure control)
Integrierter widerstand (blin-
kleuchtenausfallkontrolle)

NEW



213010
(OE 1415545)

AMP MCP-4P-M

Position Glowing - Stop - Clignotant
Glowing position - Stop - Indicator
Glowing Schlußlicht - Bremslicht - Blinker

NEW



213090
(OE 1415546)

AMP MCP-4P-M

Position Glowing - Stop - Clignotant
Glowing position - Stop - Indicator
Glowing Schlußlicht - Bremslicht - Blinker

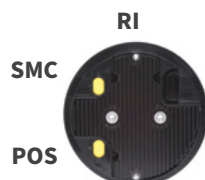



AMP-MCP-4P-F

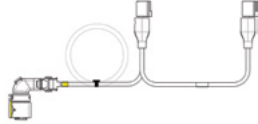

D14846

(OE 1415543)

HDSCS-6P-F

gauche - left - links

AMP-MCP-4P-F

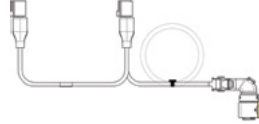

D14847

(OE 1415544)

HDSCS-6P-F

droit - right - rechts

AMP-MCP-4P-F



D14884

(OE 1437099)

HDSCS-6P-F

gauche - left - links

AMP-MCP-4P-F

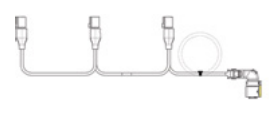

D14885

(OE 1437100)

HDSCS-6P-F

droit - right - rechts



LED



10/30V



D14488

(OE 1348566)



LC12 LED

 p. 138

LED

 24V



161000

gauche - left - links



AMP 1.5-7P-M

arrière
rear connector
Anschlussstecker hinten



161010

droit - right - rechts



D11868

AMP 1.5-7P-F



D14781

gauche - left - links

SS-2P-F



D14782

droit - right - rechts

SS-2P-F

LC8T

 p. 157



156040

gauche - left - links



AMP 1.5-7P-M

arrière
rear connector
Anschlussstecker hinten



156050

droit - right - rechts



056700

gauche - left - links



056710

droit - right - rechts



D12712

gauche - left - links

POS-2P-F



D12711

droit - right - rechts

POS-2P-F



D11868

AMP 1.5-7P-F

EPP96 LED

 p. 180

LED

 24V



R14364

2000 mm

SS-2P-F

SOR IBERICA

EPP96

 p. 181



D11888

1000 mm

CLICK-IN

SMD04

 p. 196

LED

 24V



104100

1500 mm

CLICK-IN



104650

1000 mm

bride rallongée - extended bracket - Montagewinkel längerter

CLICK-IN

SMCU

 p. 196

 12/24V



D14722

SS-2P-M **SS-3P-M**

FA3LED

 p. 207

LED

 12/24V



D14427

1500 mm

gauche - left - links

CLICK-IN



D14428

1500 mm

droit - right - rechts

CLICK-IN



D14425

gauche - left - links

SS-2P-F



D14426

droit - right - rechts

SS-2P-F

SH3

 p. 236

 H3/55W
12V

09/2017 ->



D14156
(OE 48159167)

DT-2P-M



D14170

DT-2P-F

RH3

 p. 236

 H3/55W
12V

01/2021 ->



D14654
(OE 51431987)

DT-2P-M



D14170

DT-2P-F

STILL

CL 1 LED

 p. 244

LED

 12/24V



D14649

RL 1000

 p. 225

LED

 12/24V

 1000 Lumen



D14853

DT-2P-M



D14170

DT-2P-F

SHD BLUE

 p. 239

LED

 12/24V-100V



D14249

DT-2P-M



D14170

DT-2P-F

FRESNEL

 p. 259

LED

 10/110V



D14746



BL15

 p. 145

LED

 24V

NEW



DT04-4P-M



DTM06-4S-4P-F

NEW



165040

gauche - left - links

165050

droit - right - rechts



D14436 DT06-4S-4P-F



D14437 DTM06-4S-4P-F



D14435 DTM04-4P-M

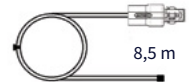

R14338 DT06-4S-4P-F

CTL15

 p. 144

LED

 24V

NEW



DT04-4P-M



DTM06-4S-4P-F

NEW



164020

gauche - left - links

164030

droit - right - rechts



D14436 DT06-4S-4P-F



D14437 DTM06-4S-4P-F



D14435 DTM04-4P-M



R14339 DT06-4S-4P-F

CTL15-BL15

 p. 145

LED

 24V

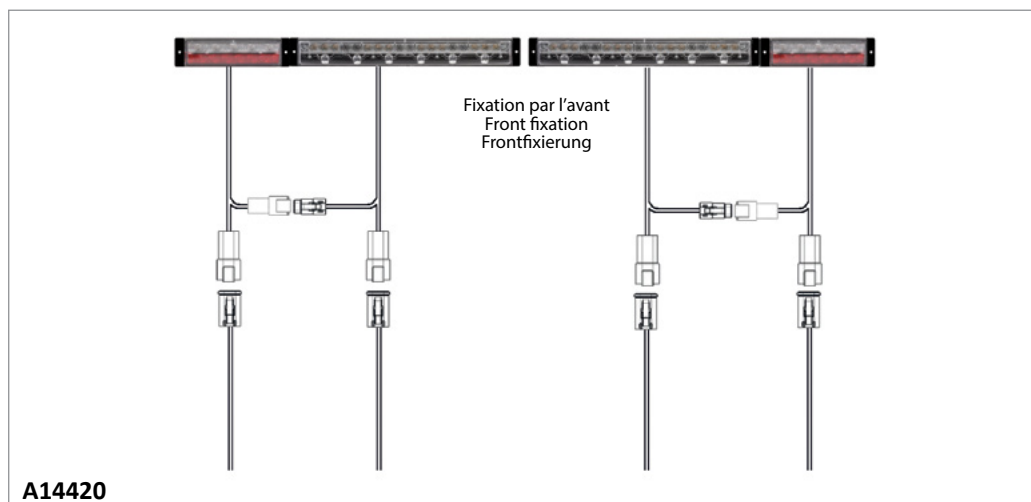

A14420

2 x CTL15 + 1 x BL15 gauche + 1 x BL15 droit + 4 câbles 8,5 m
2 x CTL15 + 1 x left BL15 + 1 x right BL15 + 4 cables 8,5 m
2 x CTL15 + 1 x BL15 links + 1 x BL15 rechts + 4 Verkabelung 8,5 m

UD TRUCKS

QUON - QUESTER

LC5

 p. 163

05/2015 ->



153860
(OE 261319Z01B) 

153880 *
(OE 261319Z01D) 

gauche - left - links



AMP 1.5-7P-M

arrière
rear connector
Anschlussstecker hinten



153870
(OE 261319Z01C) 

153890 *
(OE 261319Z01E) 

droit - right - rechts

* pas de fonction brouillard
* no fog function
* ohne Nebelschlussleuchte



D11868 AMP 1.5-7P-F



052500
(OE 265509Z00A) 

gauche - left - links



052500
(OE 265509Z00A) 

droit - right - rechts

EPP98

 p. 181

05/2015 ->



196010
(OE 265109Z00A)
JPT-2P-M



D13876 JPT-2P-F

ICDL15

 p. 186

05/2015 ->



120000
(OE 84655961) PY21W - 24V
SS-2P-M



D13880 SS-2P-F

CHL 1 LED p. 242

LED

 12/24V



D14324
(OE 101 4 734)
gauche - left - links



DT-6P-M
arrière
rear connector
Anschlusstecker hinten



D14325
(OE 101 4 735)
droit - right - rechts



D14352 **DT-6P-F**

CARBONLUX p. 230

LED

 10/30V



D14548
(OE 101 1 102)

DT-2P-M



D14170 **DT-2P-F**

VEGA LED p. 256

LED

 10/30V



D14508
(OE 101 4 681)



D14509
(OE 101 4 211)



VEGA p. 261

 H1 -12/24V



D14478
(OE 101 2 421)



LC8

 p. 151

06/2017 ->



155570
(OE 7CA 945 095)
gauche - left - links



AMP 1.5-7P-M
arrière
rear connector
Anschlusstecker hinten



155580
(OE 7CA 945 096)
droit - right - rechts



D11868 **AMP 1.5-7P-F**



055020
(OE 7CA 945 111)
gauche - left - links





055030
(OE 7CA 945 112)
droit - right - rechts



LC5

 p. 161

06/2017 ->



152180
(OE 7CA 945 091)
gauche - left - links



AMP 1.5-7P-M
arrière
rear connector
Anschlusstecker hinten



152180
(OE 7CA 945 092)
droit - right - rechts





D11868 **AMP 1.5-7P-F**



052500
(OE 5001847153)
gauche - left - links





052500
(OE 5001847153)
droit - right - rechts



LC8

 p. 156

06/2006 ->
05/2017



156340
(OE 2E0 945 095 A)
gauche - left - links



AMP 1.5-7P-M
arrière
rear connector
Anschlusstecker hinten



156350
(OE 2E0 945 096 A)
droit - right - rechts



D11868 **AMP 1.5-7P-F**



056540
(OE 2E0 945 111 A)
gauche - left - links





056550
(OE 2E0 945 112 A)
droit - right - rechts



FH

LC9 LED

i | p. 142

12/2012 ->

LED

24V



158030
(OE 82849894 / 84195505 / 84441766 / 23354972) K FPL EPP
gauche - left - links



AMP 1.5-7P-M
latéral
side connector
Anschlusstecker seitlich



158050
(OE 82849923 / 84195521 / 84441768 / 23354974) K FPL
droit - right - rechts



158040
(OE 82849925 / 84195519 / 84441767 / 23354973) K FPL W
droit - right - rechts



D11868 **AMP 1.5-7P-F**



058000
(OE 82849905) K
gauche - left - links



058000
(OE 82849905) K
droit - right - rechts

SRD08

i | p. 185

09/2012 ->

LED

24V



111000
(OE 82151157)
gauche - left - links



111010
(OE 82151205)
droit - right - rechts



111020
(OE 21346521)
gauche - left - links



111030
(OE 21346522)
droit - right - rechts

FH 08/2008 -> 09/2012

LED

 24V



107000
(OE 82114506 / 82355678 / 84139927)
gauche - left - links



107010
(OE 82114500 / 82355684 / 84139939)
droit - right - rechts



107040
(OE 82114504 / 21448885)
gauche - left - links



107050
(OE 82114502 / 21478751)
droit - right - rechts



FE08 H2

09/2012 ->

LED

 24V



112010
(OE 82278930)
gauche - left - links



112000
(OE 82278938)
droit - right - rechts



ID08

09/2012 ->

LED

 24V



114000
(OE 21214534)



114010
(OE 82150539)



114020
(OE 21214524)



FH

FE08 H1

09/2012 ->

LED

24V



116010
(OE 82349220)

116030
(OE 21368782)

gauche - left - links



116000
(OE 82349221)



116020
(OE 21368783)

droit - right - rechts



116040
(OE 82348508)

116050
(OE 21368779)

116060
(OE 21368781)



FE07

08/2008 ->

LED

24V



207000
(OE 82116545)



207010
(OE 21087346)



207020
(OE 21087347)

SL08

09/2012 ->

5W



113000
(OE 82202076)

Lampe de portière
Door lamp
Türleuchte

ATLAS

 p. 252

04/2021 ->

NEW

LED

 9/32V



212730
(OE 23742314)



TYCO MCON-2P-M

FH - FM

SH3

 p. 237

 H3/70W-24V



D12111
(OE 20872890)

SHD 1200

 p. 227

05/2014 -> 12/2015

LED

 9/36V



D14161
(OE 84185589)

DT-2P-M



D14170

DT-2P-F

FH - FM - FL

SMD00

 p. 198

2001 ->

LED

 24V



198620
(OE 82392733)

K

Cuve blanche - cabochon PMMA
White body - PMMA lens
Weißes Gehäuse - PMMA Lichtscheibe



198740
(OE 84044658)



K

Cuve ambre - cabochon PC haute température
Amber body - PC lens high temperature
Oranges Gehäuse - PC Lichtscheibe hoch temperatur beständig



001766
(OE 85105029)

adaptateur - adaptor - adapterkabel

FM



LC10 LED p. 143

09/2013 ->

LED

 24V





159500   
(OE 82483074 / 84441759 /
23522307 / 23690769)

gauche - left - links





AMP 1.5-7P-M
latéral
side connector
Anschlussstecker seitlich



159530  
(OE 21735299 / 84441937
23522305 / 23690765)



droit - right - rechts



159520  
(OE 21735301 / 84441936 /
23522304 / 23690764)

gauche - left - links



159510   
(OE 82483073 / 84441760 /
23522308)

droit - right - rechts



D11868 **AMP 1.5-7P-F**



059500 
(OE 84122332)
gauche - left - links



059500 
(OE 84122332)
droit - right - rechts

SRD07 p. 185

09/2010 -> 10/2013

LED

 24V



107000
(OE 82114506 / 82355678)
gauche - left - links



107010
(OE 82114500 / 82355684)
droit - right - rechts



107040
(OE 82114504 / 21448885)
gauche - left - links



107050
(OE 82114502 / 21478751)
droit - right - rechts

11/2013 ->



107500
(OE 82467736)
gauche - left - links



107510
(OE 82467737)
droit - right - rechts

FE07

08/2008 ->

LED

24V



207000
(OE 82116545)



207010
(OE 21087346)



207020
(OE 21087347)

LC9

p. 160

01/2006 ->



159010
(OE 20769775)
gauche - left - links



AMP 1.5-7P-M
latéral
side connector
Anschlussstecker seitlich



159020
(OE 20769776)
droit - right - rechts



159030
(OE 20769777)
droit - right - rechts



D11868 **AMP 1.5-7P-F**



059000
(OE 20802418)
gauche - left - links



059000
(OE 20802418)
droit - right - rechts



D12953

FL - FE

LC5

 p. 161

2006 ->



152190
(OE 20769783)
gauche - left - links





AMP 1.5-7P-M
arrière
rear connector
Anschlusstecker hinten



152200
(OE 20769784)
droit - right - rechts



152880
(OE 20769781)
gauche - left - links





152880
(OE 20769782)
droit - right - rechts





D11868 **AMP 1.5-7P-F**



052000
(OE 20537280)

052500
(OE 20745060)

gauche - left - links





052000
(OE 20537280)

052500
(OE 20745060)

droit - right - rechts



ICDL94

 p. 187



119550
(OE 21341202)

JPT-3P-M



001616
(OE 20745227)



D13877 **JPT-3P-F**

FE95

 p. 193



195010
(OE 20745225)
gauche - left - links



195010
(OE 20745225)
droit - right - rechts

FL - FE

SH3

 p. 237

- * Lampe fournie
- * Bulb included
- * Inklusiv Glühlampen



D13019*
(OE 21396991)

DT-2P-M



D14170

DT-2P-F

FL

EPP98

 p. 181



196010
(OE 20721495)

JPT-2P-M



D13876

JPT-2P-F

FE02

 p. 193

2006 ->



102200
(OE 20717520)

Clippé - clipped - clip-befestigung

JPT-2P-M



001726
(OE 20745066)

D13876

JPT-2P-F



FPL93

 p. 200



193020
(OE 20734485 / 84538758)

JPT-2P-M



001726
(OE 20745066)

D13876

JPT-2P-F



SMD98

 p.197

LED

 24V

-> 2003



198650
(OE 20480486)

K

JPT-2P-M



D13876

JPT-2P-F

SMD98

 p.203

LED

 24V

-> 2003



198640
(OE 70364301)

K

JPT-2P-M



D13876

JPT-2P-F

VOLVO CONSTRUCTION

SMD98

 p.197

LED

 24V



198520
(OE 11170068)

K

JPT-2P-M



D13876

JPT-2P-F

CHL1H4

 p.243

 24V
H4 - PY21 - W5W



D14320 12V

D14322 24V

gauche - left - links



DT-6P-M

arrière
rear connector
Anschlussstecker hinten



D14321 12V

D14323 24V

droit - right - rechts



D14352

DT-6P-F

TRI

 p.217



D10596
(OE 23374865)

K

Feux arriere

Rear lamps

Heckleuchten

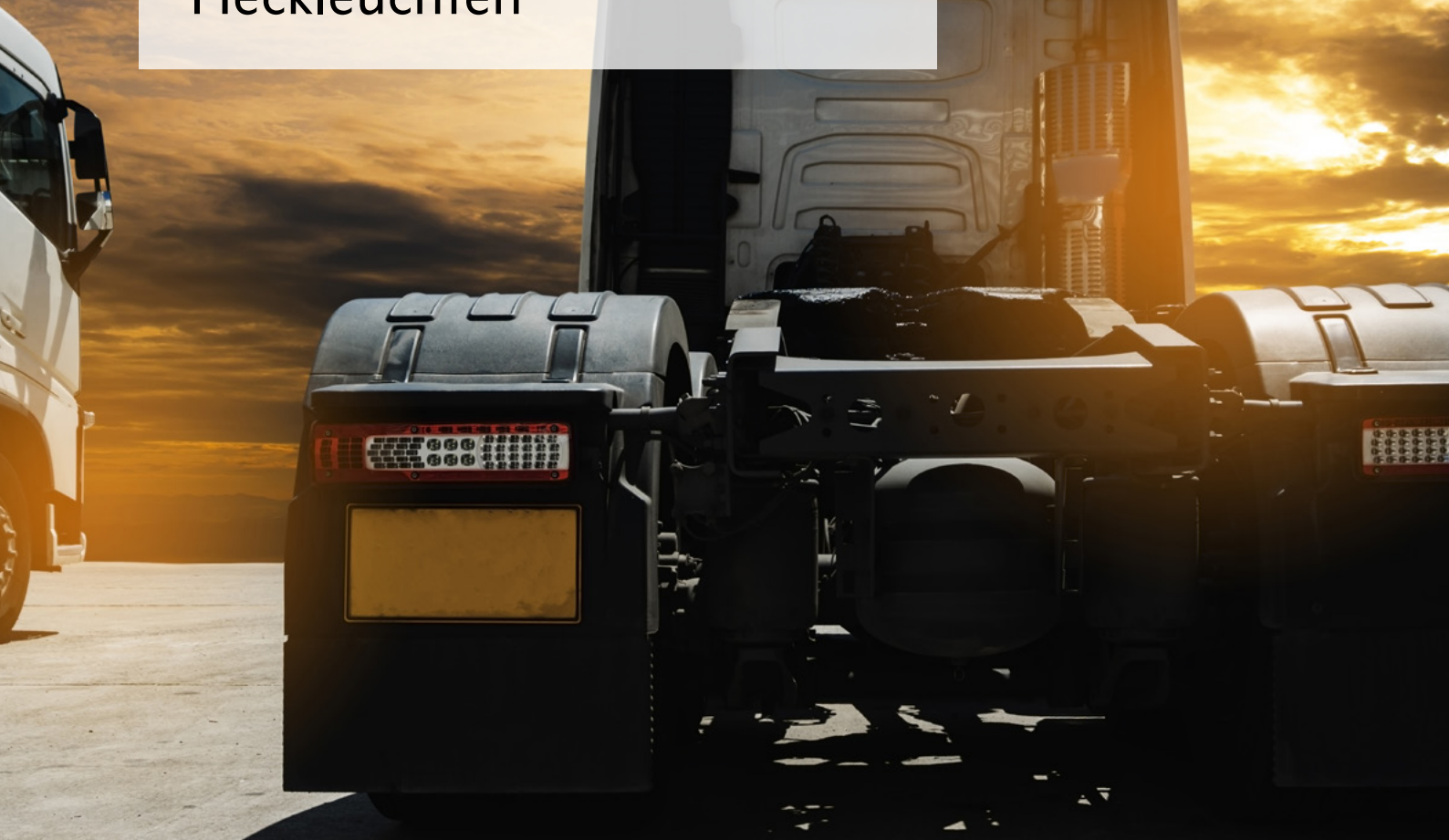

LED

p. 138-149



Halogene

p. 150-177



K Catadioptr
Reflector
Rückstrahler

T Catadioptr triangulaire
Triangular reflector
Dreieckrückstrahler

FPL Feu de position latéral
Side marker lamp
seitenmarkierungsleuchte

EPP Eclaireur de plaque
Number plate lamp
Kennzeichenleuchte

Al Alarme sonore de recul
Back up alarm
Rückfahrhorn

+ Connecteurs additionnels
Additional connectors
Zusätzliche elektrische anschlüsse

AMP 1,5-7P-M



Type connecteur - Nb pins - Mâle ou Femelle
Connector type - Pins Nb - Male or Female
Steckertyp - Stifte Nb - männlich oder weiblich

Flashez le QR code pour plus d'infos
Scan the QR code for more info
Scannen Sie den QR-Code für weitere Informationen

Pièces détachées
Spare parts
Ersatzteile

Numéro d'homologation
Approval number
Zulassungsnummer

Sens de montage
Mounting direction
Einbaurichtung



Faisceau p. 307
Harness p. 307
Anschlusskabel siehe S. p. 307

DETAIL CONNECTEUR 1.5	Support des Connecteurs Pin/Socket	FUNCTION
	1	STOP
	2	POSITION
	3	REAR
	4	INDICATEUR DE DIRECTION
	5	STOP
	6	REAR/LAMP
	7	NOT USED

Pinning connecteurs sur notre site web
Connectors pinning on our website
Anschlüsse feststecken auf unsere Website

Feux arriere - Rear lamps - Heckleuchten

LC12 LED

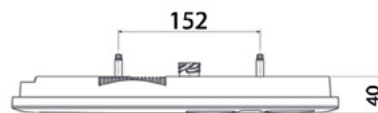
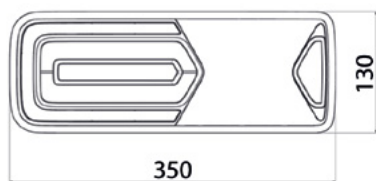

ORIGINAL



LED

ADR



E₂ 16027
10R-0516057

Affectations constructeurs
OE applications
Fahrzeugverwendung

ASCA p. 8
BENALU p. 12
DE BUF p. 28
FELDBINDER p. 32
FRUEHAUF p. 35
GUILLEN p. 37
LAMBERET p. 61
MAGYAR p. 69
OMEPS p. 82
SCHMITZ p. 117
SOR IBERICA p. 119



161000 24V

161200 12V

gauche - left - links



AMP 1.5-7P-M
arrière
rear connector
Anschlussstecker hinten



161010 24V

161210 12V

droit - right - rechts



161120 24V

161260 24V

161190 24V

gauche - left - links



161130 24V

161270 24V

161180 24V

droit - right - rechts

GLOWING



LED

ADR



E₂ 18042
10R-0516057



161280 24V

161420 12V

gauche - left - links



AMP 1.5-7P-M
arrière
rear connector
Anschlussstecker hinten



161290 24V

161430 12V

droit - right - rechts



161500 24V

161560 24V

161460 24V

gauche - left - links



161510 24V

161570 24V

161470 24V

droit - right - rechts



ORIGINAL



GLOWING



Clignotant dynamique
Dynamic indicator
Dynamisch blinker



4 connecteurs pour options
4 connectors for options
4 Anschlüsse für Optionen

Resistance intégrée (contrôle défaillance indicateur)
Integrated resistance (indicator failure control)
Integrierter widerstand (blinkleuchtenausfallkontrolle)

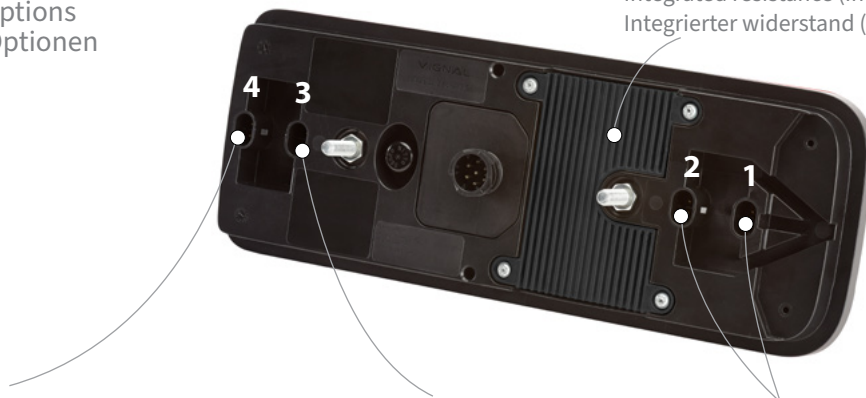

1+2+4 = 1 Amp maxi
3 = 1 Amp maxi

Position latéral clignotant
Side marker flashing lamp
Blinkende seiten markierungs leuchte



Recul
Reverse
Rückfahr



Position
Schlußlicht



CLICK-IN

104090

500 mm



104100

1500 mm



D14857

DT-2P-M



R14364

2000 mm

SS-2P-F



D11868

AMP 1.5-7P-F



SS-2P-F

R14412

16 m



DT-2P-F

SS-2P-F

R14413

1500 mm



D14781

SS-2P-F

gauche - left - links



D14782

SS-2P-F

droit - right - rechts



SS-2P-M

SS-2P-F

R14426

1500 mm

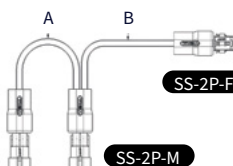

SS-2P-F

SS-2P-M

R14418

A : 300 mm / B: 500 mm



D14425

1500 mm

SS-2P-F

gauche - left - links



D14426

1500 mm

SS-2P-F

droit - right - rechts

Rallonge SUPERSEAL 2 voies
2 poles SUPERSEAL extension lead
Verlängerungsschnur Anschlussstecker 2 polig

Feux arriere - Rear lamps - Heckleuchten

LC11

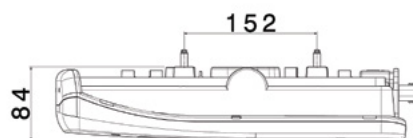
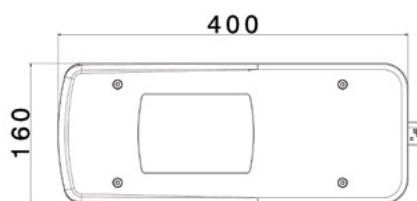

LED

24V

ADR

H

14085
E₂ 14086 -FPL
10R-047585

Affectations constructeurs
OE applications
Fahrzeugverwendung

IVECO p. 43



160150

gauche - left - links

K FPL



HDSCS-8P-M

latéral
side connector
Anschlussstecker seitlich



160100

droit - right - rechts

K FPL



160080

gauche - left - links

K FPL EPP



160090

droit - right - rechts

K FPL



160110

gauche - left - links

K FPL



HDSCS-8P-M

arrière
rear connector
Anschlussstecker hinten



160130

droit - right - rechts

K FPL



160140

gauche - left - links

K FPL EPP



160120

droit - right - rechts

K FPL



D13878

HDSCS-8P-F



060000

gauche - left - links

K



060010

droit - right - rechts

K

LC11

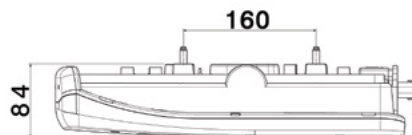
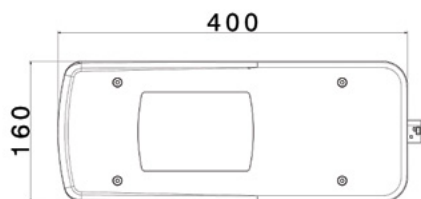

LED

12V

ADR

H

E2 14085
14086 -FPL
10R-047585

Affectations constructeurs
OE applications
Fahrzeugverwendung

MERCEDES p. 77



160400

gauche - left - links

K FPL EPP



AMP 1.5-7P-M
arrière
rear connector
Anschlussstecker hinten



160410

droit - right - rechts

K FPL



D11868

AMP 1.5-7P-F



060000

gauche - left - links

K



060010

droit - right - rechts

K



Feux arriere - Rear lamps - Heckleuchten

LC9 LED

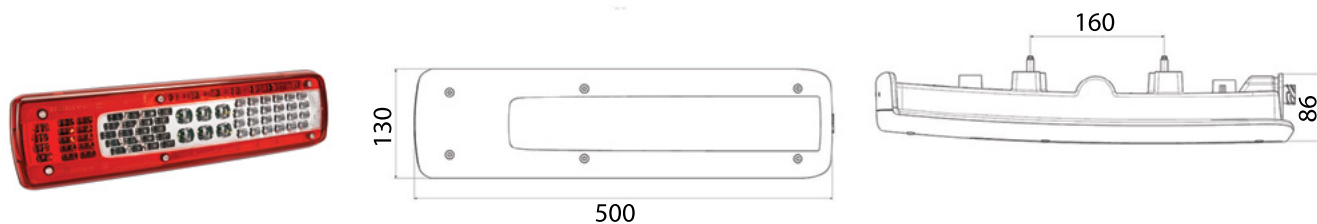

LED

24V



E2 10113
10R-036227

Affectations constructeurs
OE applications
Fahrzeugverwendung

RENAULT TRUCKS p. 86
VOLVO TRUCKS p. 127



158030

gauche - left - links



AMP 1.5-7P-M

latéral
side connector
Anschlussstecker seitlich



158050

droit - right - rechts



158040

droit - right - rechts



D11868

AMP 1.5-7P-F



058000

gauche - left - links



058000

droit - right - rechts



LC10 LED

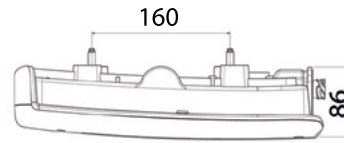

LED

24V



E2 12164
10R-036854

Affectations constructeurs
OE applications
Fahrzeugverwendung

RENAULT TRUCKS p. 87
VOLVO TRUCKS p. 131



159520

gauche - left - links



AMP 1.5-7P-M

latéral
side connector
Anschlusstecker seitlich



159530

droit - right - rechts



159500

gauche - left - links



159510

droit - right - rechts



D11868

AMP 1.5-7P-F



059500

gauche - left - links



059500

droit - right - rechts

Feux arriere - Rear lamps - Heckleuchten

CTL15



LED

24V

1200 Lumen



E₂ 16005

Affectations constructeurs
OE applications
Fahrzeugverwendung

CHEREAU p. 19
LECAPITAINE p. 65
TROUILLET p. 123

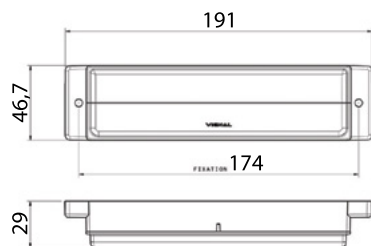

DT04-4P-M



Fixation par l'arrière
Back fixation
Rückenfixierung

164000

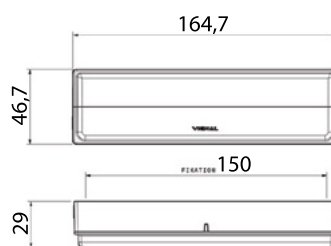

DT04-4P-M



DTM04-4P-M



164010

Pour raccordement sur feu BL15
To plug in BL15 lamp
Zum direkten Anschluss an die leuchte BL15



DT04-4P-M



Fixation par l'avant
Front fixation
Frontfixierung

164020



DT04-4P-M



DTM04-4P-M



164030

Pour raccordement sur feu BL15
To plug in BL15 lamp
Zum direkten Anschluss an die leuchte BL15

BL15



LED

24V



E₂ 16007
10R-0516079

Affectations constructeurs
OE applications
Fahrzeugverwendung

CHEREAU p. 19
FRUEHAUF p. 35
LECAPITAINE p. 65
TROUILLET p. 123

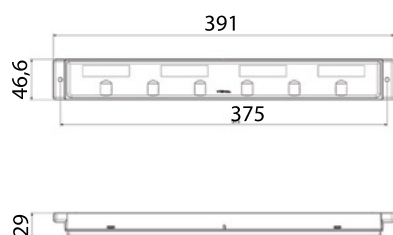

DT04-4P-M



Fixation par l'arrière
Back fixation
Rückenfixierung

165020

gauche - left - links



DTM06-4S-4P-F



Fixation par l'avant
Front fixation
Frontfixierung

165040

gauche - left - links

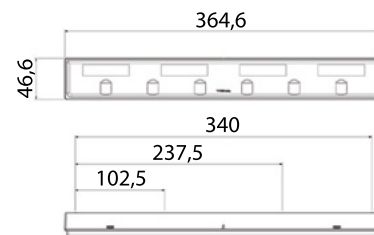

165030

droit - right - rechts



165050

droit - right - rechts

CTL15 - BL15



Indicateur de direction à défilement - feux de détresse flash
 Dynamic indicator lights - warning lights
 Dynamischer Blinker - blinkende Warnleuchte



Feu de travail 1200 Lumen
 Work light 1200 Lumen
 Arbeitsscheinwerfer 1200 Lumen

Stop et position
 Stop and position
 Bremsleuchte und Schlussleuchte



CTL15 - BL15

LED

24V

1200 Lumen



16005
 16007
 10R-0516079

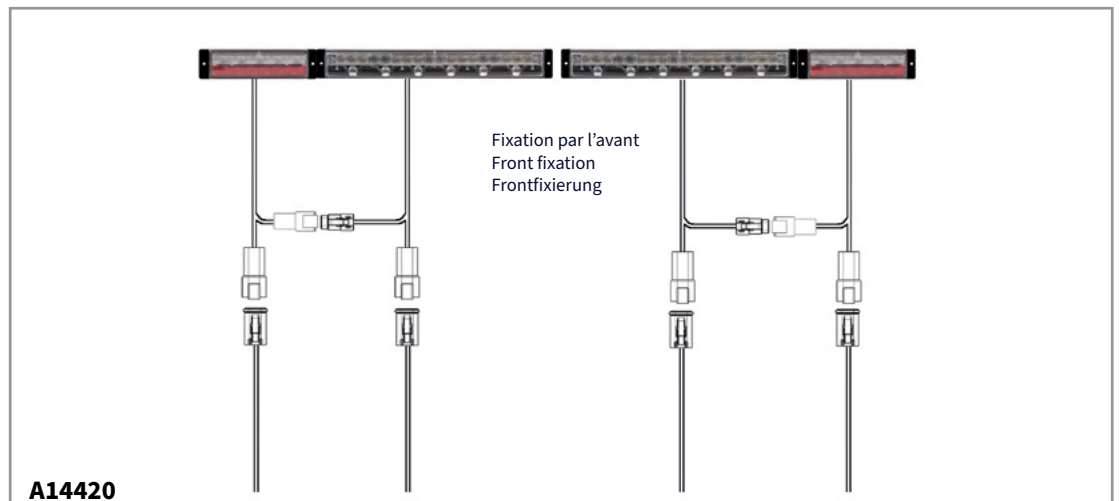

2 x CTL15 + 1 x BL15 gauche + 1 x BL15 droit + 4 câbles 8,5 m
 2 x CTL15 + 1 x left BL15 + 1 x right BL15 + 4 cables 8,5 m
 2 x CTL15 + 1 x BL15 links + 1 x BL15 rechts + 4 Verkabelung 8,5 m

Feux arriere - Rear lamps - Heckleuchten

LCR19

GLOWING

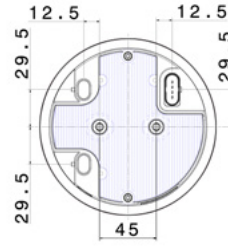
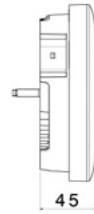
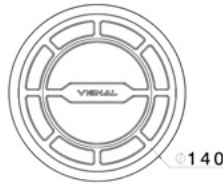

NEW

LED

24V



E₂ 19106

Affectations constructeurs
OE applications
Fahrzeugverwendung

SCHMITZ p. 117



213010

AMP MCP-4P-M

Position Glowing - Stop - Clignotant
Glowing position - Stop - Indicator
Glowing Schlusslicht - Bremslicht - Blinker



213070

AMP MCP-4P-M

Position Glowing - Stop - Clignotant
Glowing position - Stop - Indicator
Glowing Schlusslicht - Bremslicht - Blinker



213090

AMP MCP-4P-M

Position Glowing - Stop - Clignotant
Glowing position - Stop - Indicator
Glowing Schlusslicht - Bremslicht - Blinker

RI

SMC

POS

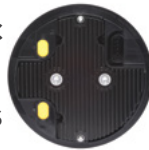

POS

POS



Connecteurs additionnels Superseal 2 voies mâle
Additional connectors Superseal 2 pin male
Zusätzliche elektrische anschlüsse Superseal Männlich 2 polig

NEW

R23



213150

AMP MCP-4P-M

Recul - Brouillard
Reverse - Fog
Rückfahrlicht - Nebelschlusslicht



213160

AMP MCP-4P-M

Recul - Brouillard
Glowing position - Stop - Indicator
Glowing Schlusslicht - Bremslicht - Blinker



213200

AMP MCP-4P-M

Position Glowing - Recul - Brouillard
Glowing position - Reverse - Fog
Glowing Schlusslicht - Rückfahrlicht - Nebelschlusslicht



002100

Anneau chromé
Chrome ring
Chromring



* SMC
Position latéral clignotant
Side marker flashing lamp
Blinkende seiten markierungs leuchte

POS
Position
Schlußlicht

R23
Recul
Reverse
Rückfahr

RI
Resistance intégrée (contrôle défaillance indicateur)
Integrated resistance (indicator failure control)
Integrierter widerstand (blinkleuchtenausfallkontrolle)

LCR19

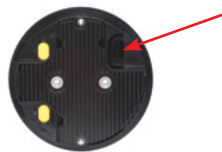

D14984	AMP-MCP-4P-F	D14980	AMP 1.5-7P-M	D14983
	AMP-MCP-4P-F			AMP-MCP-4P-F

Affectations constructeurs
OE applications
Fahrzeugverwendung

SCHMITZ p. 117

D14846	D14847	D14884	D14885
gauche - left - links	droit - right - rechts	gauche - left - links	droit - right - rechts

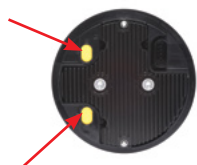

SMC		POS		POS		POS	
	CLICK-IN		SS-2P-F		SS-2P-F		SS-2P-F
104090	500 mm K	R14364	2000 mm	D14425	1500 mm	D14426	1500 mm
104100	1500 mm K			gauche - left - links		droit - right - rechts	

R14412	16 m	R14426	1500 mm	R14418	A: 300 mm / B: 500 mm

Rallonge SUPERSEAL 2 voies
2 poles SUPERSEAL extension lead
Verlängerungsschnur Anschlussstecker 2 polig

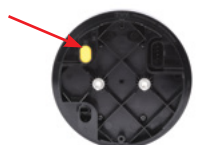

R23	DT-2P-M	SS-2P-F	
D14857		R14413	1500 mm

* **SMC**
Position latéral clignotant
Side marker flashing lamp
Blinkende seiten markierungs leuchte

POS
Position
Schlußlicht

R23
Recul
Reverse
Rückfahr

RI
Resistance intégrée (contrôle défaillance indicateur)
Integrated resistance (indicator failure control)
Integrierter widerstand (blinkleuchtenausfallkontrolle)

Feux arriere - Rear lamps - Heckleuchten

CTL14

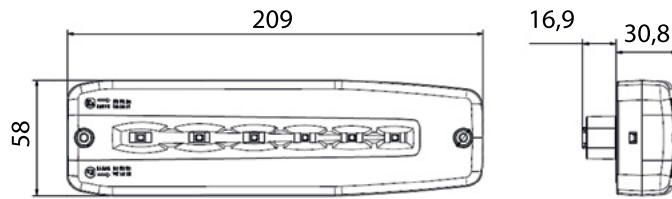

LED

12/24V



E2 16111
10R-17254



DT04-4P-M
arrière
rear connector
Anschlussstecker hinten



D14436 DT06-4S-4P-F

163010

gauche/droit - left/right - links/rechts



Stop - position - clignotant dynamique
Stop - position - dynamic direction indicator
Bremsleuchte - Schlussleuchte - Dynamisch wischender blinker



SLIM

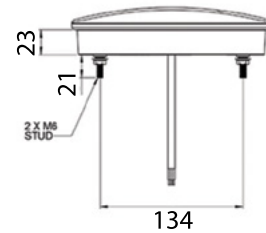
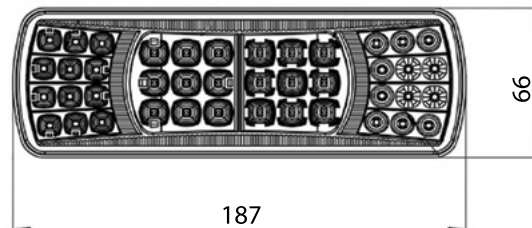

LED

12/24V



E9 11734
10R-051614

* fils nus - naked cable extre-
mity - Kabellitze



5 FONCTIONS - FUNCTIONS - FUNKTIONEN

D13817*

gauche/droit - left/right - links/rechts



Stop - position - clignotant - recul - antibrouillard
Stop - position - direction indicator - reverse - fog
Bremsleuchte - Schlussleuchte - Blinker - Rückfahrleuchte - Ne-
belschlussleuchte



FRR

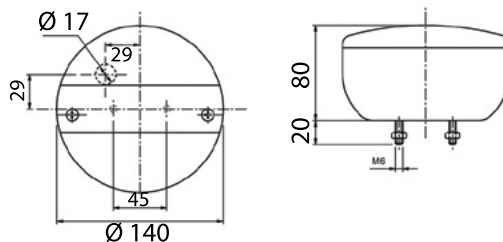

LED

12/24V



13992
E4 23271
4052



IP67

* cosses plates - flat plugs -
Flachstecker



D13816 *
gauche/droit - left/right - links/rechts



D14189 *
feu de recul
reverse lamp
rückfahrleuchte



D14188 *
feu de brouillard
fog lamp
nebelschlussleuchte



Stop - position - clignotant
Stop - position - direction indicator
Bremsleuchte - Schlussleuchte - Blinker

FRR

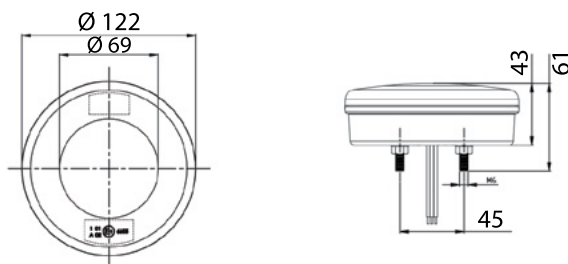

LED

12/24V



6653
E9 1288
10R-041489
10R-041487



IP67

* fils nus - naked cable extre-
mity - Kabellitze



D14348*
gauche/droit - left/right - links/rechts

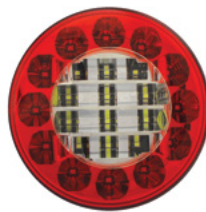

D14345*
feu de recul - brouillard
reverse - fog lamp
rückfahrleuchte - nebelschlussleuchte



Stop - position - clignotant
Stop - position - direction indicator
Bremsleuchte - Schlussleuchte - Blinker

Feux arriere - Rear lamps - Heckleuchten

LC8

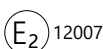
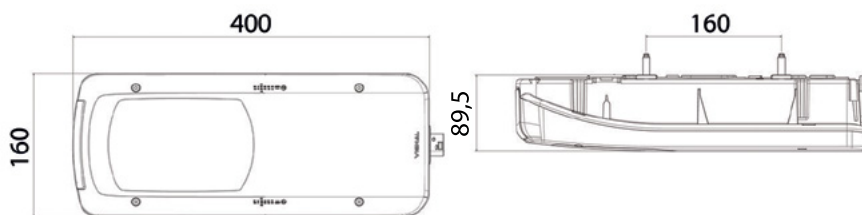

Affectations constructeurs
OE applications
Fahrzeugverwendung

DAF p. 23



155100
gauche - left - links



HDSCS-8P-M

latéral
side connector
Anschlussstecker seitlich



155110
droit - right - rechts



155120
droit - right - rechts



155130
gauche - left - links



HDSCS-8P-M

arrière
rear connector
Anschlussstecker hinten



155140
droit - right - rechts



155150
droit - right - rechts



D13878

HDSCS-8P-F



055020
gauche - left - links



055030
droit - right - rechts



001830



Feux arriere - Rear lamps - Heckleuchten

LC8

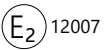
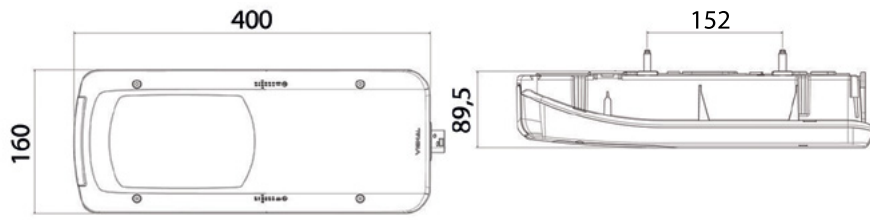

Affectations constructeurs
OE applications
Fahrzeugverwendung

VOLKSWAGEN p. 126



155570

gauche - left - links



AMP 1.5-7P-M
arrière
rear connector
Anschlussstecker hinten



155580

droit - right - rechts



D11868

AMP 1.5-7P-F



055020

gauche - left - links



055030

droit - right - rechts



Feux arriere - Rear lamps - Heckleuchten

LC8

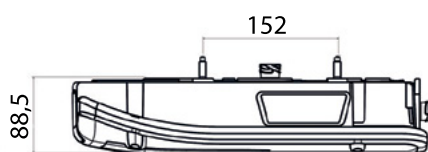
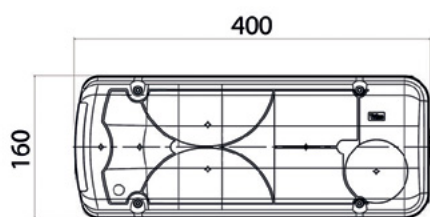

Affectations constructeurs
OE applications
Fahrzeugverwendung
IVECO p. 44

DESIGN EFFET FUMÉ - MÉTALLISÉ
SMOKED EFFECT & METTALIZED DESIGN



155450

gauche - left - links



HDSCS-8P-M

latéral
side connector
Anschlusstecker seitlich



155460

droit - right - rechts



155470

droit - right - rechts



155480

gauche - left - links



HDSCS-8P-M

arrière
rear connector
Anschlusstecker hinten



155490

droit - right - rechts



155540

gauche - left - links



155500

droit - right - rechts



D13878

HDSCS-8P-F



055040

gauche - left - links



055050

droit - right - rechts



001830



Feux arriere - Rear lamps - Heckleuchten

LC8

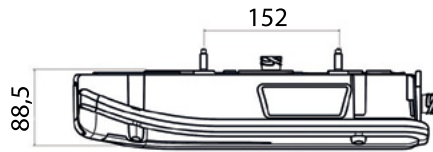
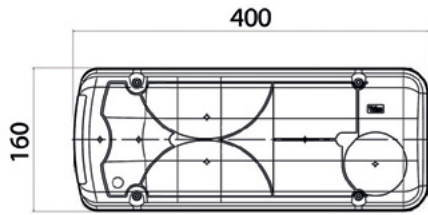

Affectations constructeurs
OE applications
Fahrzeugverwendung

MAN p. 70



156200

gauche - left - links



AMP 1.5-7P-M

latéral
side connector
Anschlusstecker seitlich



156210

droit - right - rechts



001872 55-90 db



156220

droit - right - rechts



Affectations constructeurs
OE applications
Fahrzeugverwendung

MAN (TGE) p. 71

* vis arrière de 31 mm
* 31 mm rear bolts
* hintere Schraube 31 mm



155550 *

gauche - left - links

12V



AMP 1.5-7P-M

arrière
rear connector
Anschlusstecker hinten



155560 *

droit - right - rechts

12V



D11868

AMP 1.5-7P-F

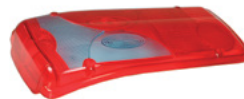

056500

gauche - left - links



056500

droit - right - rechts

Feux arriere - Rear lamps - Heckleuchten

LC8

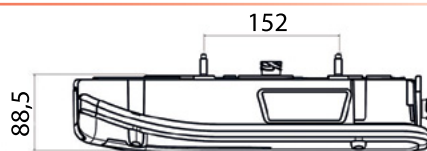
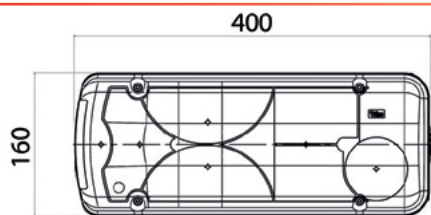

ADR



E₂ 2040

Affectations constructeurs
OE applications
Fahrzeugverwendung
[CHEREAU p. 20](#)
[LAMBERET p. 62](#)



156550

gauche - left - links

FPL



AMP 1.5-7P-M

arrière
rear connector
Anschlussstecker hinten

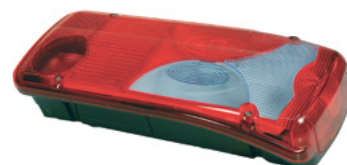

156540

droit - right - rechts

FPL



156310

gauche - left - links

K FPL

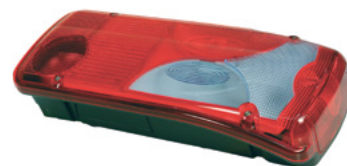

156300

droit - right - rechts

K FPL



156290

gauche - left - links

K FPL EPP



D11868

AMP 1.5-7P-F



056000

056500

gauche - left - links

K



056010

056510

droit - right - rechts

K

LC8

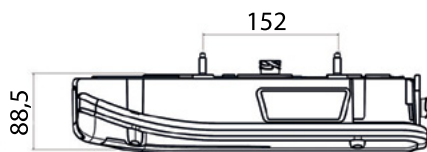
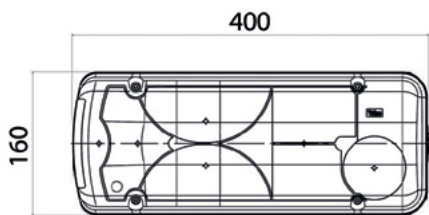

Affectations constructeurs
OE applications
Fahrzeugverwendung

SCANIA p. 115



156770

gauche - left - links



AMP 1.5-7P-M

latéral
side connector
Anschlussstecker seitlich



156780

droit - right - rechts



155020

gauche - left - links



156790

droit - right - rechts



155080

gauche - left - links



AMP 1.5-7P-M

arrière
rear connector
Anschlussstecker hinten



155520

droit - right - rechts



155090

droit - right - rechts



D11868

AMP 1.5-7P-F



056540

gauche - left - links



056550

droit - right - rechts



001830



Feux arriere - Rear lamps - Heckleuchten

LC8

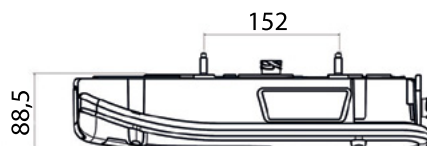
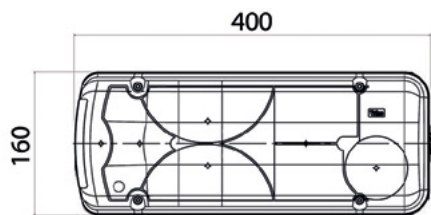

Affectations constructeurs
OE applications
Fahrzeugverwendung

MERCEDES p. 77
VOLKSWAGEN p. 126



156590

gauche - left - links



AMP 1.5-7P-M

arrière
rear connector
Anschlussstecker hinten



156600

droit - right - rechts



156340

gauche - left - links



156350

droit - right - rechts



D11868

AMP 1.5-7P-F



056020

056540

gauche - left - links



056030

056550

droit - right - rechts



LC8T

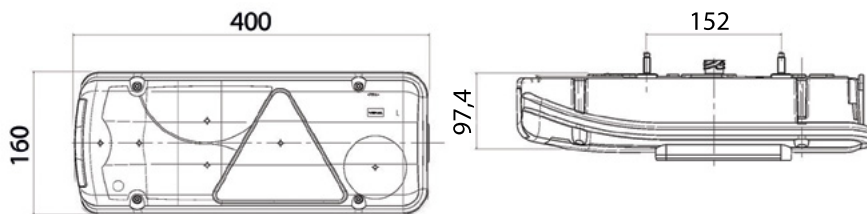

Affectations constructeurs
OE applications
Fahrzeugverwendung

ASCA p. 8
BENALU p. 12
CHEREAU p. 20
FRUEHAUF p. 35
GUILLEN p. 37
LAMBERET p. 61
SOR IBERICA p. 119



156040
gauche - left - links



AMP 1.5-7P-M
arrière
rear connector
Anschlusstecker hinten



156050
droit - right - rechts



156060
gauche - left - links



156070
droit - right - rechts



156130
droit - right - rechts



156630
gauche - left - links



AMP 1.5-7P-M
latéral
side connector
Anschlusstecker seitlich



156640
droit - right - rechts



Repiquage fonctions stop et positions
Plug-in stop and positions functions
Anschluss zusätzliche Brems und Positionsluchten

Pour - For - Für :
156040 - 156050 - 156060 - 156070 - 156130 - 156170 - 156250 - 156260 - 156290 - 156300 - 156310 - 156380 -
156390 - 156540 - 156550 - 156590 - 156600

Câblage - Harness - Anschlusskabel p. 300

Feux arriere - Rear lamps - Heckleuchten

LC8



Affectations constructeurs
OE applications
Fahrzeugverwendung

ASCA p. 8
BENALU p. 12
CHEREAU p. 20
FRUEHAUF p. 35
GUILLEN p. 37
LAMBERET p. 61
SOR IBERICA p. 119



D11868 AMP 1.5-7P-F



056700 gauche - left - links



056710 droit - right - rechts



001830



001846
cales - spacers - abstandhalter

LED

12/24V



D14038 500 mm
gauche - left - links



D14037 500 mm
droit - right - rechts



D14039 350 mm
gauche - left - links



D14040 350 mm
droit - right - rechts

W5W

12/24V



D13034 500 mm
gauche - left - links



D13035 500 mm
droit - right - rechts



D12712 350 mm
gauche - left - links



D12711 350 mm
droit - right - rechts

LC8T

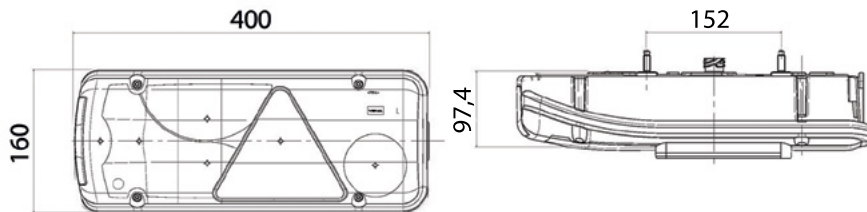

Affectations constructeurs
OE applications
Fahrzeugverwendung

FELDBINDER p. 32
LECIÑENA p. 66



156250

gauche - left - links



AMP 1.5-7P-M

arrière
rear connector
Anschlusstecker hinten



156260

droit - right - rechts



156380

gauche - left - links



156390

droit - right - rechts



D11868

AMP 1.5-7P-F



056720

gauche - left - links



056730

droit - right - rechts



Feux arriere - Rear lamps - Heckleuchten

LC9

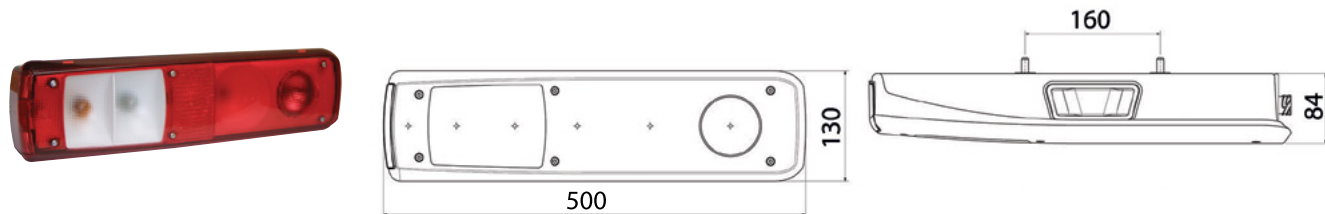

E₂ 04075

Affectations constructeurs
OE applications
Fahrzeugverwendung

RENAULT TRUCKS p. 87
VOLVO TRUCKS p. 132



159010

gauche - left - links



AMP 1.5-7P-M

latéral
side connector
Anschlussstecker seitlich



159020

droit - right - rechts



159030

droit - right - rechts



D11868

AMP 1.5-7P-F



059000

gauche - left - links



059000

droit - right - rechts



D12953



LC5

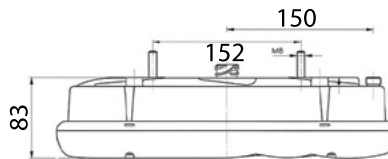
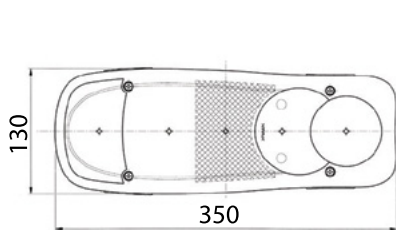

E₂ 8005

Affectations constructeurs
OE applications
Fahrzeugverwendung

BOBCAT p. 15
DAF p. 25
IVECO p. 49
MANITOU p. 73
MANITOWOC p. 75
NISSAN p. 81
OPEL p. 84
RENAULT TRUCKS p. 99
VOLKSWAGEN p. 126
VOLVO TRUCKS p. 133



152130

152150

gauche - left - links



PG 13

arrière
rear connector
Anschlussstecker hinten



152130

152150

droit - right - rechts



152160

152140

gauche - left - links



AMP 1.5-7P-M

arrière
rear connector
Anschlussstecker hinten



152200

152180

droit - right - rechts



152190

152170

gauche - left - links



153120

droit - right - rechts



D11868

AMP 1.5-7P-F



052000

052500

gauche - left - links



052000

052500

droit - right - rechts



D13288

grille de protection réversible
homologuée - homologated
protective grid - Schutzgitter
genehmigt

Feux arriere - Rear lamps - Heckleuchten

LC5

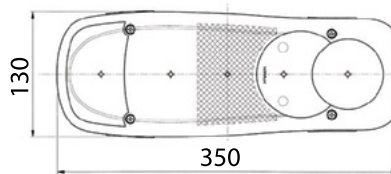

E₂ 8005

Affectations constructeurs
OE applications
Fahrzeugverwendung

FIAT p. 34
PEUGEOT CITROËN p. 85



Fixation 4 vis M6 (190x60mm)
Fixing 4 screws M6 (190x60mm)
Befestigung 4 Schrauben M6
(190x60mm)



153270

gauche - left - links



AMP 1.5-7P-M

arrière
rear connector
Anschlussstecker hinten



153280

droit - right - rechts



D11868

AMP 1.5-7P-F



052500

gauche - left - links



052500

droit - right - rechts



LC5

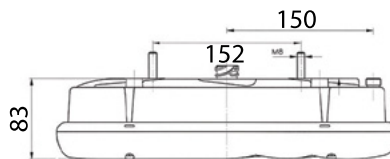
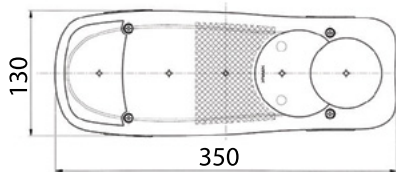

Affectations constructeurs
OE applications
Fahrzeugverwendung

IVECO p. 45



153220

gauche - left - links



AMP 1.5-7P-M

arrière
rear connector
Anschlusstecker hinten



153210

droit - right - rechts



153200

gauche - left - links

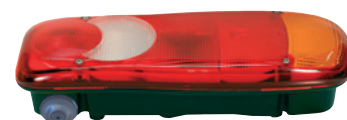

153230

droit - right - rechts



153240

gauche - left - links



153250

droit - right - rechts



153260

droit - right - rechts



D11868

AMP 1.5-7P-F



052500

gauche - left - links



052500

droit - right - rechts



Feux arriere - Rear lamps - Heckleuchten

LC5T

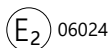
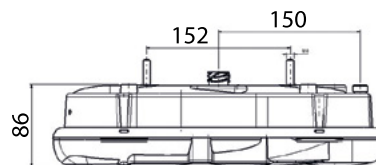
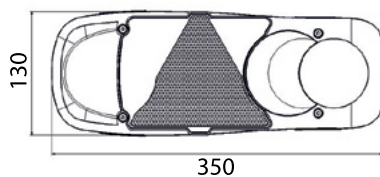

Affectations constructeurs
OE applications
Fahrzeugverwendung

ASCA p. 9
LAMBERET p. 62
LECIÑENA p. 66



153040

gauche - left - links



PG 13

arrière
rear connector
Anschlussstecker hinten



153050

droit - right - rechts



153060

gauche - left - links



153070

droit - right - rechts



153000

gauche - left - links



AMP 1.5-7P-M

arrière
rear connector
Anschlussstecker hinten



153010

droit - right - rechts



153130

droit - right - rechts



153020

gauche - left - links



153030

droit - right - rechts



D11868

AMP 1.5-7P-F

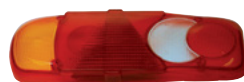

053700

gauche - left - links

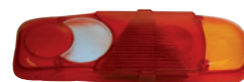

053710

droit - right - rechts



LC5TDX

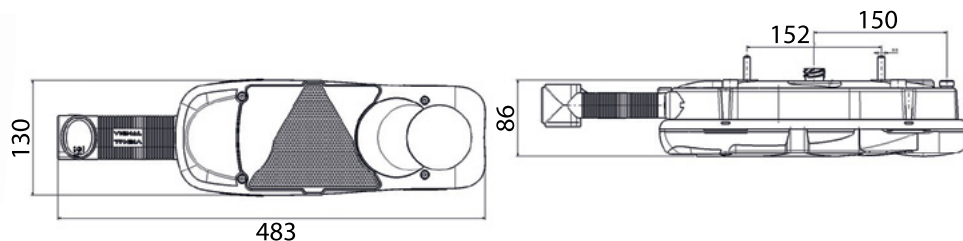

E2 06024 (sans DX)
07092 (avec DX)

Affectations constructeurs
OE applications
Fahrzeugverwendung

ASCA p. 9



153660

gauche - left - links



AMP 1.5-7P-M

arrière
rear connector
Anschlussstecker hinten



153670

droit - right - rechts



153700

gauche - left - links



153710

droit - right - rechts



D11868

AMP 1.5-7P-F

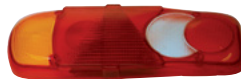

053700

gauche - left - links

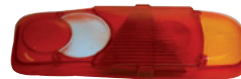

053710

droit - right - rechts



D12430



D12471



D12472

Lampe non fournie - bulb
not included - nichte inklusiv
glühlampen



D12473

Feux arriere - Rear lamps - Heckleuchten

LC7

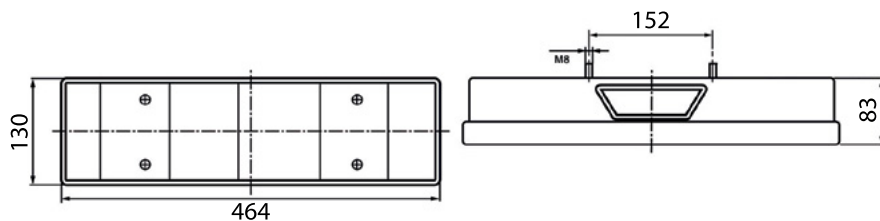

E₂ 88017 (LC7)
88035 (LC7K)

Affectations constructeurs
OE applications
Fahrzeugverwendung

RENAULT TRUCKS p. 91



167100

EPP

167600

K EPP

gauche - left - links



PE
arrière
rear connector
Anschlussstecker hinten



167000

167500

K

gauche - left - links



168270

K FPL

gauche - left - links



168270

K FPL

droit - right - rechts



168340

K FPL EPP

gauche - left - links

Affectations constructeurs
OE applications
Fahrzeugverwendung

MAN p. 71



168090

K FPL

gauche - left - links



DIN 72480-8P-M
arrière
rear connector
Anschlussstecker hinten



168090

K FPL

droit - right - rechts



168100

K FPL EPP

gauche - left - links



067000

067500

gauche - left - links



067000

067500

droit - right - rechts

Feux arriere - Rear lamps - Heckleuchten

LC7

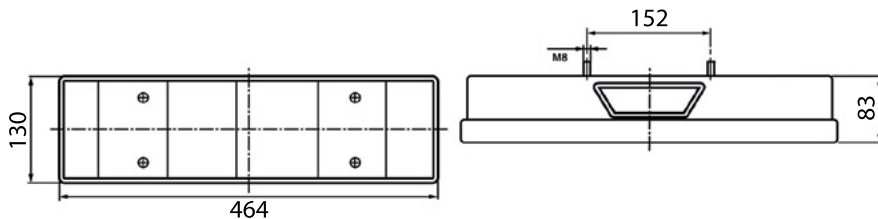

E₂ 88035 (LC7K)

Affectations constructeurs
OE applications
Fahrzeugverwendung

DAF p. 24
MAN p. 72

Affectations constructeurs
OE applications
Fahrzeugverwendung

IVECO p. 48

EURO 5



169180
gauche - left - links



AMP 1.5-7P-M
latéral
side connector
Anschlusstecker seitlich



169170
169190
droit - right - rechts



169160
gauche - left - links



IVECO
arrière
rear connector
Anschlusstecker hinten



168590
gauche - left - links



168600
droit - right - rechts



168610
gauche - left - links



168480
droit - right - rechts



D11868 **AMP 1.5-7P-F**



067500
gauche - left - links



067500
droit - right - rechts

Feux arriere - Rear lamps - Heckleuchten

LC7

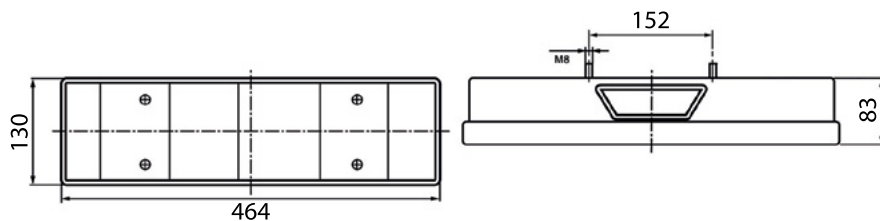

E₂ 88035 (LC7K)

Affectations constructeurs
OE applications
Fahrzeugverwendung

DAF p. 24

Affectations constructeurs
OE applications
Fahrzeugverwendung

IVECO p. 46

EURO 6



168020

gauche - left - links



DAF
arrière
rear connector
Anschlussstecker hinten



168010

droit - right - rechts



169390

gauche - left - links



DIN 72480-8P-M
arrière
rear connector
Anschlussstecker hinten



169410

droit - right - rechts



169400

gauche - left - links



169420

droit - right - rechts



D11868

AMP 1.5-7P-F



067500

gauche - left - links



067500

droit - right - rechts



D12953



LC7T

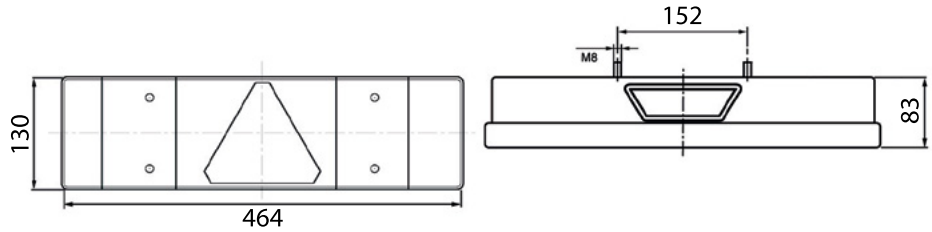

9056



167530



168770



gauche - left - links



PE
arrière
rear connector
Anschlussstecker hinten



167550



168790



droit - right - rechts



168780



gauche - left - links



168800



droit - right - rechts



168830



droit - right - rechts



067610



gauche - left - links



067600



droit - right - rechts

Feux arriere - Rear lamps - Heckleuchten

LC6

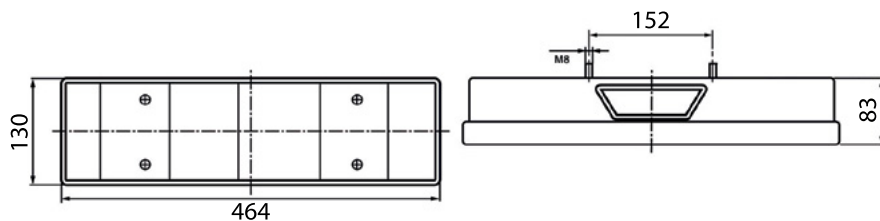

E2 88033 (LC6)
88034 (LC6K)

Affectations constructeurs
OE applications
Fahrzeugverwendung

HEULIEZ p. 39
IVECO BUS p. 55
MAN p. 72
RENAULT TRUCKS p. 91



166000

gauche - left - links



PE
arrière
rear connector
Anschlussstecker hinten



166000

droit - right - rechts



166100

gauche - left - links



166100

droit - right - rechts



166600

gauche - left - links



166600

droit - right - rechts



066000

066500
gauche - left - links



066000

066500
droit - right - rechts



001706

silent blocs - schwingungsdämpfer

LC4

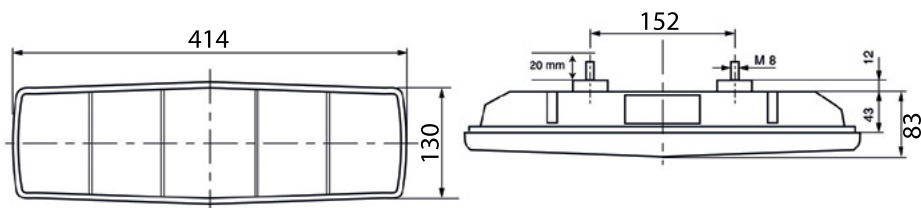

E2 91098 (LC4)
91099 (LC4K)

Affectations constructeurs
OE applications
Fahrzeugverwendung

DAF p. 27
RENAULT TRUCKSp. 108



141000 EPP
gauche - left - links



PE
arrière
rear connector
Anschlussstecker hinten



141000 EPP
droit - right - rechts



141500 K EPP
gauche - left - links



141500 K EPP
droit - right - rechts



040000
040500 K
gauche - left - links



040000
040500 K
droit - right - rechts



000046
silent blocs - schwingungsdämpfer

Feux arriere - Rear lamps - Heckleuchten

725



E13 8434

Affectations constructeurs
OE applications
Fahrzeugverwendung

IVECO p. 50

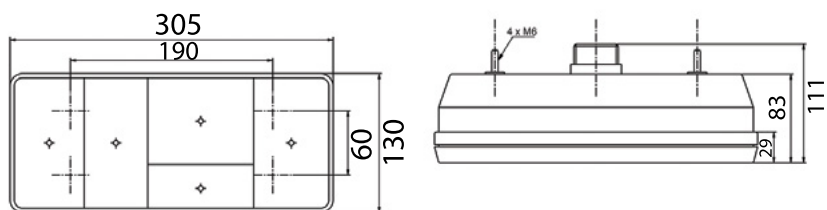

D11482

gauche - left - links



AMP 1.5-5P-M

arrière
rear connector
Anschlussstecker hinten



D11481

droit - right - rechts



D11868

AMP 1.5-7P-F



D11480

gauche - left - links



D11479

droit - right - rechts



E13 2060

Affectations constructeurs
OE applications
Fahrzeugverwendung

IVECO p. 50



D12334

gauche - left - links



AMP 1.5-6P-M

arrière
rear connector
Anschlussstecker hinten



D12335

droit - right - rechts



D11868

AMP 1.5-7P-F



D12336

gauche - left - links



D12337

droit - right - rechts



725



E₃ 51788

Affectations constructeurs
OE applications
Fahrzeugverwendung

IVECO p. 51

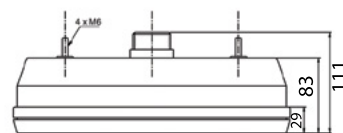
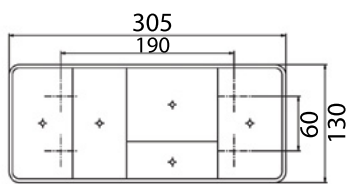
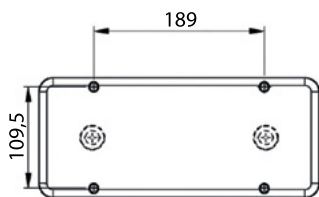

725040

gauche - left - links



IVECO
arrière
rear connector
Anschlussstecker hinten



725020

gauche - left - links



IVECO
arrière
rear connector
Anschlussstecker hinten

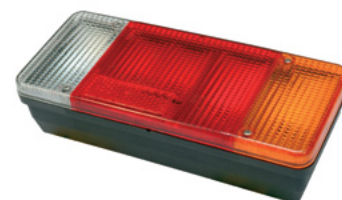

725010

droit - right - rechts



726310

gauche - left - links

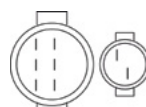

IVECO
arrière
rear connector
Anschlussstecker hinten



726320

droit - right - rechts



725002

gauche - left - links



725012

droit - right - rechts



725022

gauche - left - links



725032

droit - right - rechts



Feux arriere - Rear lamps - Heckleuchten

725



E₃ 51788

Affectations constructeurs
OE applications
Fahrzeugverwendung

IVECO p. 51

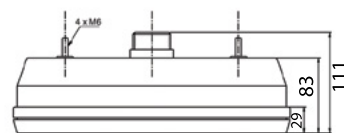
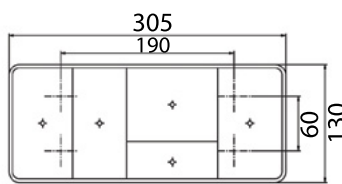
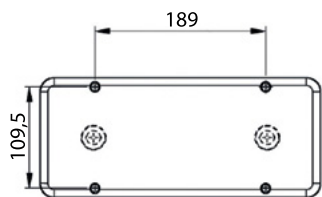

726290

gauche - left - links

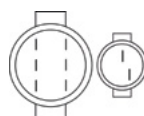

IVECO
arrière
rear connector
Anschlussstecker hinten

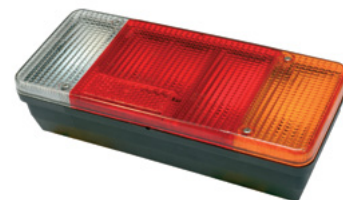

726300

droit - right - rechts



726350

gauche - left - links

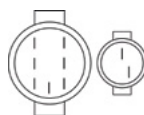

IVECO
arrière
rear connector
Anschlussstecker hinten



726450

gauche - left - links



IVECO
arrière
rear connector
Anschlussstecker hinten

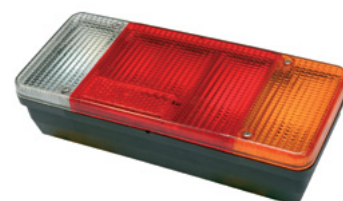

726460

droit - right - rechts



725002

gauche - left - links



725012

droit - right - rechts



725022

gauche - left - links



725032

droit - right - rechts



Feux arriere - Rear lamps - Heckleuchten

MILI



E₂ 88731 (5F)
5108 (3F)
253 (2F)

ROBUSTE ET ETANCHE
ROBUST AND WATERPROOF
ROBUST UND WASSERDICHT

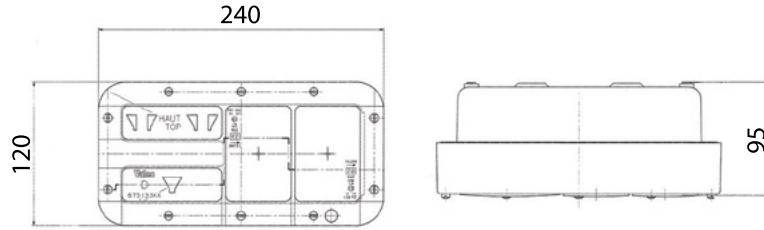

67513371 gauche - left - links

67513390

cabochon - lens - Lichtscheibe



67513361 droit - right - rechts

67513380

cabochon - lens - Lichtscheibe



60760541

position - clignotant - black out position
position - indicator - black out position
schlussleuchte - richtungsanzeiger - black out



60760551

brouillard - recul
fog - reverse
nebelschlussleuchte - rückfahrleuchte

BBS 516



E₁ 1559
53329

Affectations constructeurs
OE applications
Fahrzeugverwendung

MANITOU p. 73

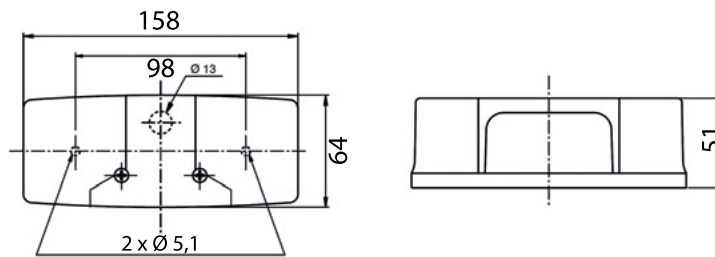

500930

gauche - left - links



PF
arrière
rear connector
Anschlussstecker hinten



500940

droit - right - rechts



Feux arriere - Rear lamps - Heckleuchten

FRR



Ø 140 mm x 80 mm

E13

9657 (3 fcts)
697
698



D10841

gauche/droit - left/right - links/rechts



PF
arrière
rear connector
Anschlussstecker hinten



D10840

P21W

feu de recul
reverse lamp
rückfahrleuchte



D10839

P21W

feu de brouillard
fog lamp
nebelschlussleuchte

Feux arriere - Rear lamps - Heckleuchten

2711



E₃ 38553

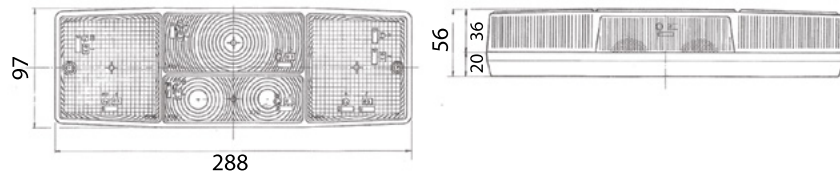

D14523
(27.11.090.VLG)

D14525
(27.11.991.VLG)
gauche - left - links



PE
arrière
rear connector
Anschlusstecker hinten



D14524
(27.11.092.VLG)

D14526
(27.11.992.VLG)
droit - right - rechts



2704



E₃ 2887

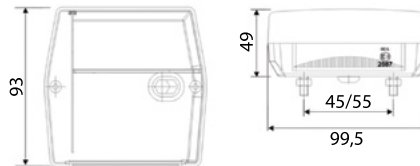

D14518
(27.04.042.VLS)
gauche/droit - left/right - links/rechts



PF
arrière
rear connector
Anschlusstecker hinten



D14527
(27.04.V66.MV7) 7,5 m
valisette 2 feux câblés magnétiques
2 wired lamps magnetic in case
Koffer 2 magnetische Kabel Lichter

Eclaireur de plaque Number plate lamps Kennzeichenleuchten

WWW.VIGNAL-GROUP.COM

LED p. 179-180

NEW



Halogene p. 181



SS-2P-F

Type connecteur - Nb pins - Mâle ou Femelle
Connector type - Pins Nb - Male or Female
Steckertyp - Stifte Nb - männlich oder weiblich



Flashez le QR code pour plus d'infos
Scan the QR code for more info
Scannen Sie den QR-Code für weitere Informationen



Pièces détachées
Spare parts
Ersatzteile



Numéro d'homologation
Approval number
Zulassungsnummer



Sens de montage
Mounting direction
Einbaurichtung



Faisceau p. 307
Harness p. 307
Anschlusskabel siehe S. p. 307

Eclaireurs de plaque - Number plate lamps - Kennzeichenleuchten

LPL18

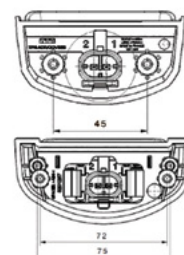
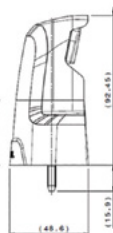
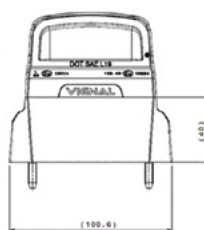
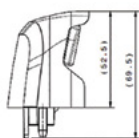
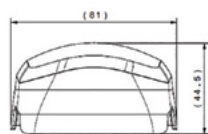

LED

12/24V

ADR



E2 19014
10R-19224

SAE

IP6K9K

NEW



199020

SS-2P-M

Entraxe 72 mm
Bolt distance 72 mm
Befestigungsmittelpunkt 72 mm



199030

SS-2P-M

Entraxe 75 mm
Bolt distance 75 mm
Befestigungsmittelpunkt 75 mm

1 seul feu LED par plaque
1 LED lamp per plate
1 LED-Licht pro Platte



199020
199030

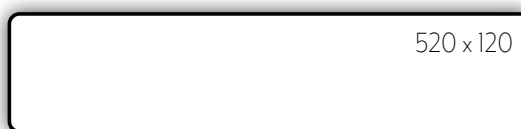

NEW



199000

SS-2P-M

clippé - clipped - clip-befestigung



199040

SS-2P-M

Entraxe 45 mm
Bolt distance 45 mm
Befestigungsmittelpunkt 45 mm

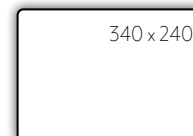
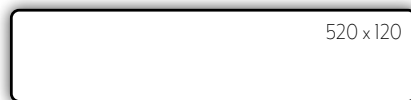
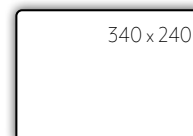
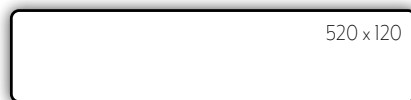

Affectations constructeurs
OE applications
Fahrzeugverwendung

CASE p. 16
IVECO p. 51
LAMBERET p. 62
NEW HOLLAND p. 80

Plus d'implantations sur
notre site web.
More positioning on our
website.
Mehr Positionierung auf
unserer Website.



D13880

SS-2P-F

SS-2P-F

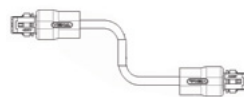

D14985

SS-2P-F



Eclaireurs de plaque - Number plate lamps - Kennzeichenleuchten

EPP96 LED



LED

24V

ADR



E₂ 11017

Affectations constructeurs
OE applications
Fahrzeugverwendung

- ASCA p. 8
- BENALU p. 12
- DE BUF p. 28
- FRUEHAUF p. 35
- GUILLEN p. 37
- LAMBERET p. 61
- OMEPS p. 82
- SOR IBERICA p. 119

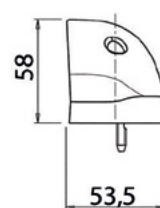
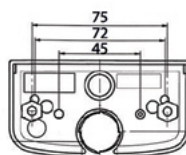
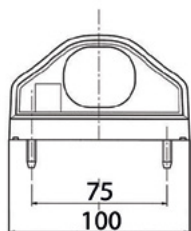

D13609 400 mm

D13610 1500 mm

CLICK-IN



R14364 2000 mm

2V Superseal
Pour / For / Für LC12T

SS-2P-F



D13874 2000 mm

2 voies - 2 poles - 2 polig
Pour / For / Für LC8

POS-2P-F

BX868



LED

12/24V

E₁₃ 10989

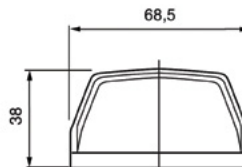
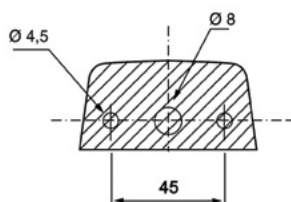

D14116 300 mm

Eclaireurs de plaque - Number plate lamps - Kennzeichenleuchten

EPP96/98



R10W



12/24V

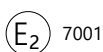

Affectations constructeurs
OE applications
Fahrzeugverwendung

- ASCA p. 8
- CHEREAU p. 21
- CLAAS p. 22
- FRUEHAUF p. 36
- GUILLEN p. 37
- LAMBERET p. 63
- MERCEDES p. 78
- RENAULT TRUCKS p. 101
- SOR IBERICA p. 120
- UD TRUCKS p. 124
- VOLVO TRUCKS p. 128

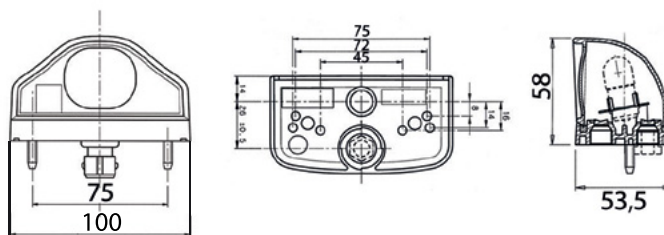

196020



000176

Affectations constructeurs
OE applications
Fahrzeugverwendung

- BOBCAT p. 15
- DAF p. 26
- OPEL p. 84
- RENAULT TRUCKS p. 101
- UD TRUCKS p. 124
- VOLVO TRUCKS p. 134



CLICK-IN

D10502

410 mm



HDSCS-3P-M

196170

500 mm



POS-2P-F

D10227

700 mm

2 voies - 2 poles - 2 polig
Pour / For / Für LC8



Affectations constructeurs
OE applications
Fahrzeugverwendung

- BOBCAT p. 15
- DAF p. 26
- OPEL p. 84
- RENAULT TRUCKS p. 101
- UD TRUCKS p. 124
- VOLVO TRUCKS p. 134



196010

JPT-2P-M



D13876

JPT-2P-F



280009

JPT-2P-F

2 m

2751



C5W



12/24V

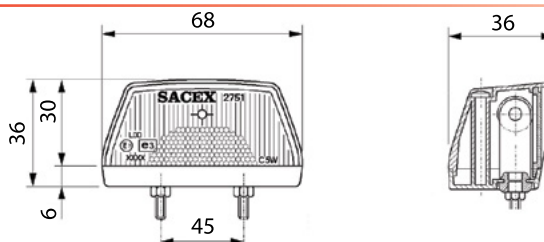
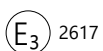

D14517

(27.51.090.VLG)

Feux clignotants

Flasher lamps

Fahrtrichtungsanzeiger

Face avant - Front face - Frontansicht

p. 183-184

Face latérale - Side face - Seitenansicht

p. 185-188

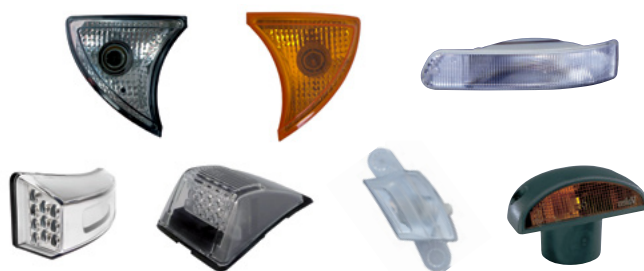

JPT-2P-F

Type connecteur - Nb pins - Mâle ou Femelle
Connector type - Pins Nb - Male or Female
Steckertyp - Stifte Nb - männlich oder weiblich



Flashez le QR code pour plus d'infos
Scan the QR code for more info
Scannen Sie den QR-Code für weitere Informationen



Pièces détachées
Spare parts
Ersatzteile



Numéro d'homologation
Approval number
Zulassungsnummer

C105

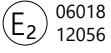

Affectations constructeurs
OE applications
Fahrzeugverwendung

[IVECO p.47](#)



110520

gauche - left - links



110530

droit - right - rechts



110550

gauche - left - links



110560

droit - right - rechts



001619

C199

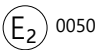

Affectations constructeurs
OE applications
Fahrzeugverwendung

[IVECO p.47](#)



119920

gauche - left - links



119930

droit - right - rechts

FLASHER UNIT



014580

Renault 5010149149
5 lampes, centrale clignotante
5 lamps, flasher unit
5 Glühlampen, Blinkereinheit

SRD08



LED

24V

E₂ 10073

Affectations constructeurs
OE applications
Fahrzeugverwendung

VOLVO TRUCKS p. 127



111000

gauche - left - links



111010

droit - right - rechts



111020

gauche - left - links



111030

droit - right - rechts

SRD07



LED

24V

E₂ 08028

Affectations constructeurs
OE applications
Fahrzeugverwendung

VOLVO TRUCKS p. 128



107000

gauche - left - links



107010

droit - right - rechts



107040

gauche - left - links



107050

droit - right - rechts



107500

gauche - left - links



107510

droit - right - rechts

Feux clignotants - Flasher lamps - Fahrtrichtungsanzeiger

ICDL15



P21W



16059



120000

Affectations constructeurs
OE applications
Fahrzeugverwendung

[UD TRUCKS p. 124](#)

ICDL10



PY21W



11128



117000

gauche - left - links



117010

droit - right - rechts

Affectations constructeurs
OE applications
Fahrzeugverwendung

[DAF p. 25](#)



001619

ICDL07



PY21W



09025



109010

Affectations constructeurs
OE applications
Fahrzeugverwendung

[DAF p. 24](#)



ICDL94



E2 5047 (R5W)
7139 (P21W)

Affectations constructeurs
OE applications
Fahrzeugverwendung

DAF p. 26
IVECO p. 52
IVECO BUS p. 55
NISSAN p. 81
RENAULT TRUCKS p. 97
VOLVO TRUCKS p. 133

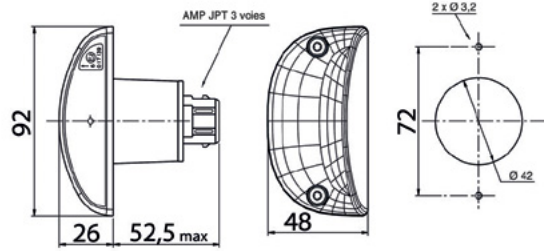

R5W

119450



119550



P21W

119470



D13877

JPT-2P-F



001616

JPT-2P-M

FE85



E2 86708
9033

Affectations constructeurs
OE applications
Fahrzeugverwendung

RENAULT TRUCKS p. 92



R5W



185040



P21W



185160

Feux clignotants - Flasher lamps - Fahrtrichtungsanzeiger

FE87



C5W



4703

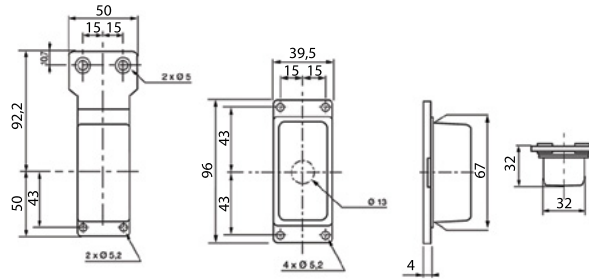

187140



187760



087040

cabochon - lens - Lichtscheibe

FE81



T4W



90711

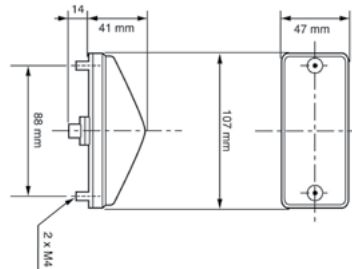

181050

181070

version pétrolière
petroleum version
für Tankfahrzeuge



000086

Feux de position

Position lamps

Positionsleuchten



Face avant - Front face - Frontansicht
p. 190-195

Face latérale - Side face - Seitenansicht
p. 196-201

Face arrière - Rear face - Heckansicht
p. 202-205



Catadioptr
Reflector
Rückstrahler



Flashez le QR code pour plus d'infos
Scan the QR code for more info
Scannen Sie den QR-Code für weitere Informationen



Pièces détachées
Spare parts
Ersatzteile



Numéro d'homologation
Approval number
Zulassungsnummer



Sens de montage
Mounting direction
Einbaurichtung



Type connecteur - Nb pins - Mâle ou Femelle
Connector type - Pins Nb - Male or Female
Steckertyp - Stifte Nb - männlich oder weiblich



Faisceau p. 307
Harness p. 307
Anschlusskabel siehe S. 307

Feux de position - Position lamps - Positionsleuchten

FE04



LED

24V

ADR



E2 05010 SAE P2

Affectations constructeurs
OE applications
Fahrzeugverwendung

ASCA p. 10
LAMBERET p. 63
RENAULT TRUCKS p. 92



p. 202

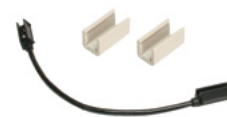
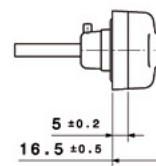
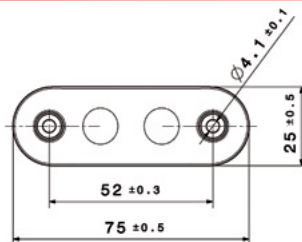

104290	500 mm
104300	1500 mm
104310	5000 mm

D10132	200 mm
---------------	--------

CLICK-IN



104570	300 mm
---------------	--------

DT-2P-M



104450	300 mm
---------------	--------

DT-2P-M



D14170	
---------------	--

DT-2P-F



104510	300 mm
---------------	--------

CLICK-IN

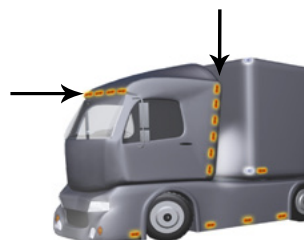

D11268	16 m
---------------	------

câble plat - flat cable - flachkabel

Feux de position - Position lamps - Positionsleuchten

SMD04

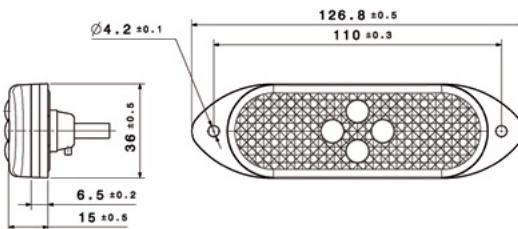

LED

24V

ADR



E₂ 05022

p. 196

p. 202



104130 500 mm **K**

104140 1500 mm **K**

104520 1000 mm **K**

104690 1000 mm **K**

CLICK-IN

adhésif - adhesive - selbstklebend

CLICK-IN

SS-2P-M

NEW

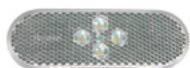

104720 **K**

SS-2P-M

SMD98

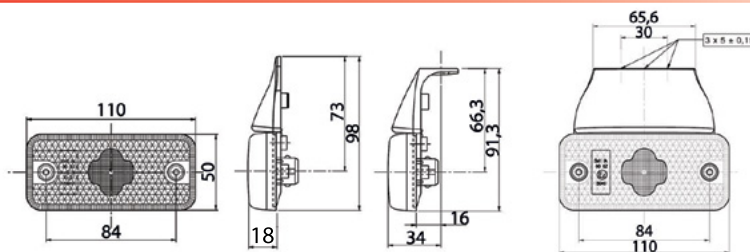

LED

12V
ou-or-oder
24V

ADR



E₂ 04010

p. 197

p. 203



198690 12V **K**

D10500 500 mm **K**

D13710 1000 mm **K**

198660 24V **K**

D11399 1500 mm **K**

D13710 1000 mm **K**

JPT-2P-M

CLICK-IN

POS-2P-F

2 voies - 2 poles - 2 polig
Pour / For / Für LC8



D13876 JPT-2P-F



001696



001716

Feux de position - Position lamps - Positionsleuchten

FE94/98



T4W



12/24V



E₂ 4088
4089 (K)

p. 198

p. 203

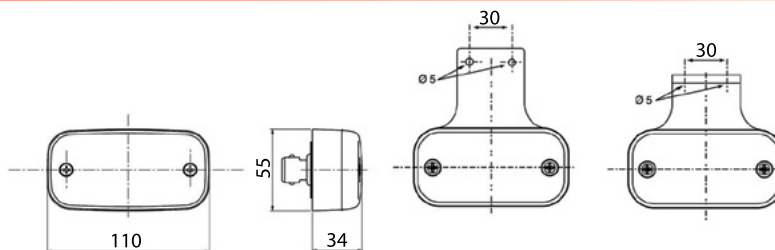

198040



JPT-2P-M



198050



194190



PE



194130



194140



194150



D13876

JPT-2P-F



000176



094046



094036



001596



001586

FE02

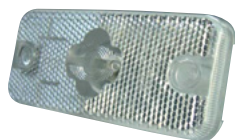
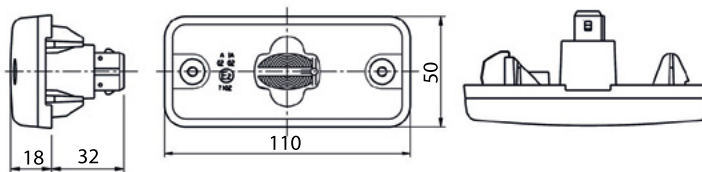

102200 K
clippé - clipped - clip-befestigung

D13876 **JPT-2P-F** **001726**

FPL93

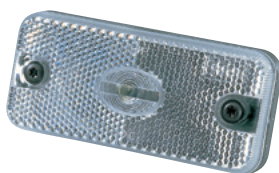
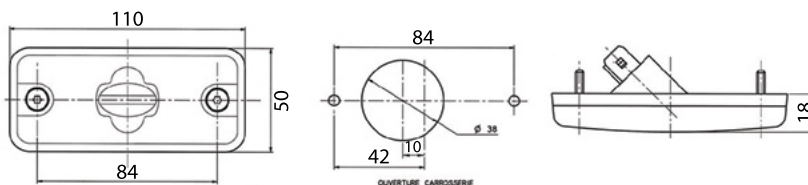

193200 K
vissé - screwed - geschraubt

D13876 **JPT-2P-F** **001726**



FE95



140 mm x 65 mm x 30,5 mm



195010
semelle plate - flat gasket - flache Sockeldichtung

195030
semelle galbée - curved gasket - gewölbte Sockeldichtung

Affectations constructeurs
OE applications
Fahrzeugverwendung

DAF p. 26
HEULIEZ p. 39
IVECO BUS p. 54
RENAULT TRUCKS p. 96
VOLVO TRUCKS p. 133

Feux de position - Position lamps - Positionsleuchten

FE85



175 mm x 68 mm x 52 mm

R5W

24V

9037



185010

semelle galbée - curved gasket - gewölbte Sockeldichtung



185020

semelle plate - flat gasket - flache Sockeldichtung

Affectations constructeurs
OE applications
Fahrzeugverwendung

HEULIEZ p. 39

IVECO BUS p. 57

RENAULT TRUCKS p. 92

FE87

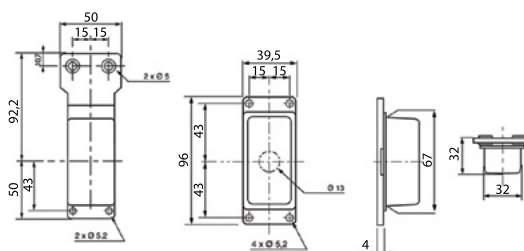

C5W

12/24V

86710



187120



187720



087020

cabochon - lens - Lichtscheibe

PLR272



C5W



12/24V

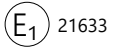

21633

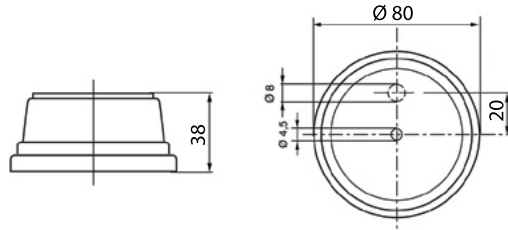

521010



521050



cabochon - lens - Lichtscheibe

FG80



R5W



12/24V

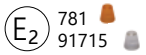

781
91715

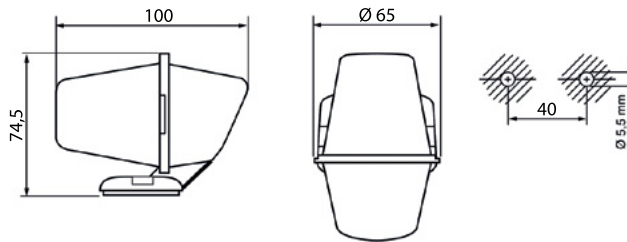

180010



080026



180040

R5W



080046

Feux de position - Position lamps - Positionsleuchten

SMD04

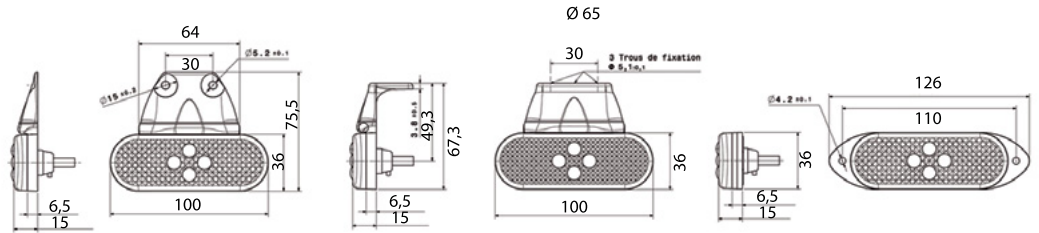

LED

24V

ADR



E₂ 05021

p. 191

p. 202



104090	500 mm	K	104210	500 mm	K	104250	500 mm	K
104100	1500 mm	K	104220	1500 mm	K	104260	1500 mm	K
CLICK-IN			CLICK-IN			CLICK-IN		



104640	300 mm	K	D12699	1000 mm	K
104650	1000 mm	K			
bride rallongée - extended bracket - Montagewinkel verlängerter			CLICK-IN		



104670		K	104700	LED-24V	K
SS-2P-M			SS-2P-M		



D13880 SS-2P-F

SMCU



FEUX DE POSITION LATÉRAUX LED CLIGNOTANTS gestion selon supplément 6 - R48
 LED SIDE MARKER FLASHING LAMPS management supp 6 - R48
 LED SEITLICHEN BLINKLEUCHTENT Ansteuerung gemäß der Erweiterung 6 - R48

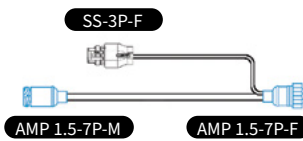

D14362 SS-3P-F



D13880 SS-2P-F

12/24V

D14722
LED Side marker control unit

D14879

Feux de position - Position lamps - Positionsleuchten

SMD98



LED

12V
ou-or-oder
24V



4xLED

2xLED

E₂ 8040

p. 191

p. 203

Affectations constructeurs
OE applications
Fahrzeugverwendung

- CASE p. 16
- FELDBINDER p. 33
- IVECO p. 45
- IVECO BUS p. 54
- LAMBERET p. 64
- LECINENA p. 67
- MERCEDES p. 78
- MANITOWOC p. 75
- NEW HOLLAND p. 80
- RENAULT TRUCKS p. 97
- VOLVO BUS p. 135
- VOLVO CONSTRUCTION p. 136

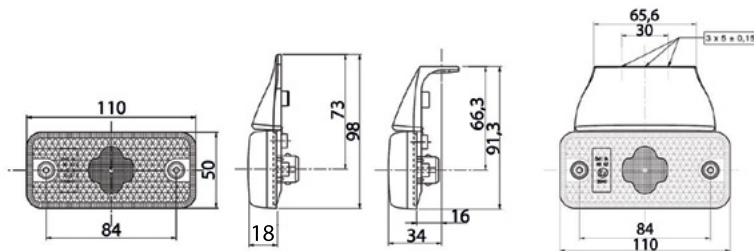

198510 4 x LED-12V K

198520 4 x LED-24V K

JPT-2P-M



198650 2 x LED-24V K

JPT-2P-M



198810 4 x LED-12V K

198760 4 x LED-24V K

SS-2P-M



198580 4 x LED-12V K

198540 2 x LED-24V K

JPT-2P-M



198530 2 x LED-24V K

JPT-2P-M



D13713 1000 mm K

2 voies - 2 poles - 2 polig
Pour / For / Für LC8



D10493 500 mm K

D10496 1500 mm K

CLICK-IN



D10494 500 mm K

D10497 1500 mm K

CLICK-IN



D10495 500 mm K

D10498 1500 mm K

CLICK-IN



D12867 2 x LED-24V K

CLICK-IN



D13876 JPT-2P-F



D13880 SS-2P-F



001696



001716

Feux de position - Position lamps - Positionsleuchten

SMD00

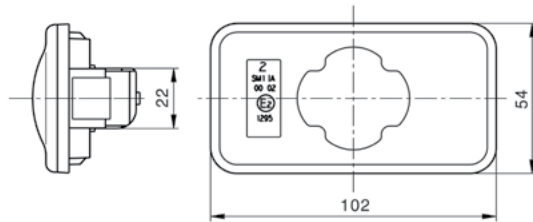

LED

24V

ADR



E₂ 1295

Affectations constructeurs
OE applications
Fahrzeugverwendung

RENAULT TRUCKS p. 88
VOLVO TRUCKS p. 130

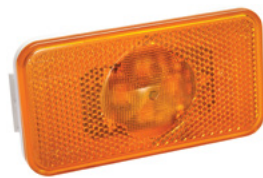

198620

K

Cuve blanche - cabochon PMMA
White body - PMMA lens
Weißes Gehäuse - PMMA Lichtscheibe



198740

K

Cuve ambre - cabochon PC résistant haute température et chocs
Amber body - high temperature and impact resistant PC lens
Oranges Gehäuse - Hochtemperatur- und schlagfestes PC Lichtscheibe



001766 600 mm

adaptateur - adaptator - Adapterkabel

FE94/98

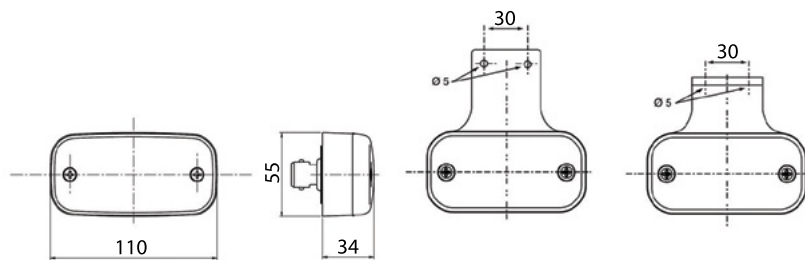

T4W

12/24V

ADR



E₂ 4092
4093 (K)

p. 192

p. 204



198010

K



198020

K



198030

K



D13876

JPT-2P-F

FE94/98

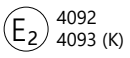

194070



PE



194010



194080



194020



194090



194030



D13876

JPT-2P-F



000176



094026



094016



001596



001586



001696



001716

Feux de position - Position lamps - Positionsleuchten

FPL93

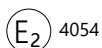
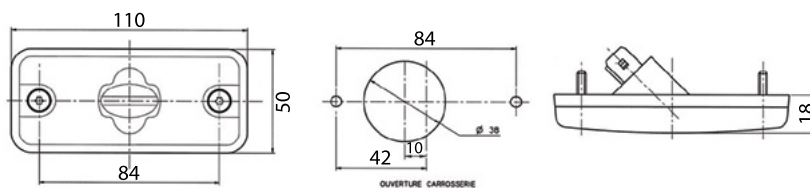

Affectations constructeurs
OE applications
Fahrzeugverwendung

- DAF p. 25
- FIAT p. 34
- HEULIEZ p. 40
- IVECO p. 45
- IVECO BUS p. 57
- RENAULT TRUCKSp. 92
- VOLVO TRUCKS p. 134



193020



JPT-2P-M



193280



JPT-2P-M



193170



SS-2P-M



193360



SS-2P-M



193290

380 mm



SS-2P-M



D13876

JPT-2P-F



D13880

SS-2P-F



001726

JPT-2P-M



001916

SS-2P-M



001696



001716

672



W3W



12/24V



1084

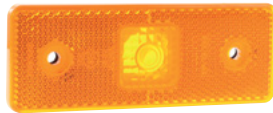
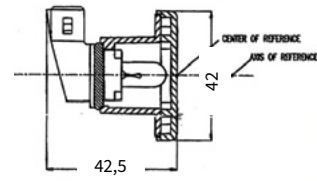
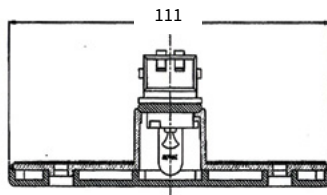

672410

200 mm



FE87



C5W



12/24V



4701

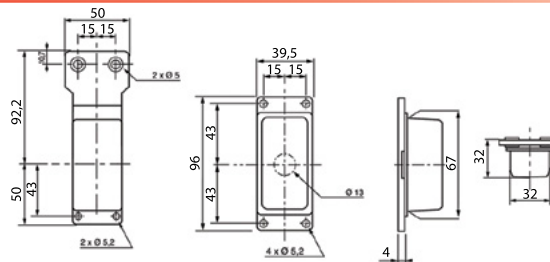

187140



187760



087040

cabochon - lens - Lichtscheibe

Feux de position - Position lamps - Positionsleuchten

FE04

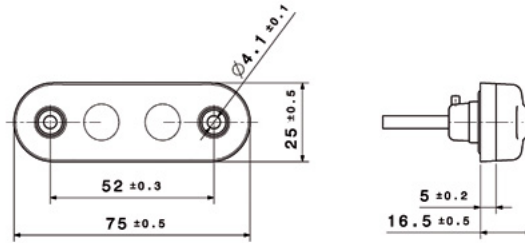

LED

24V

ADR



E2 05011

p. 190



104330	500 mm
104340	1500 mm
104360	5000 mm



D10132 200 mm
CLICK-IN

SMD04

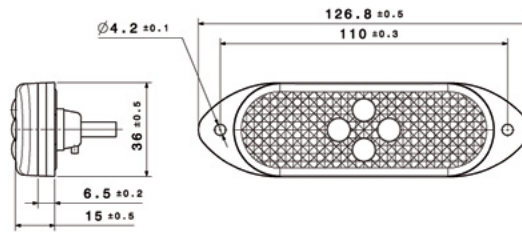

LED

24V

ADR



E2 05023

p. 191

p. 196



NEW



104170	500 mm	K
104180	1500 mm	K

CLICK-IN

104680

K

SS-2P-M

104710

K

SS-2P-M



D13880 SS-2P-F

SMD98



LED

24V

ADR

H

E₂ 2065

p. 191

p. 197

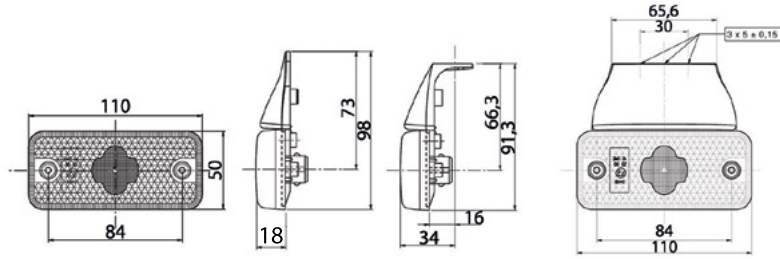

198640

K

JPT-2P-M

D11400

1500 mm

K

D10499

3500 mm

K

CLICK-IN

D13876

JPT-2P-F

001696

001716



FE94/98



T4W

12/24V

ADR

H V

E₂ 4090
4091 (K)

p. 192

p. 199

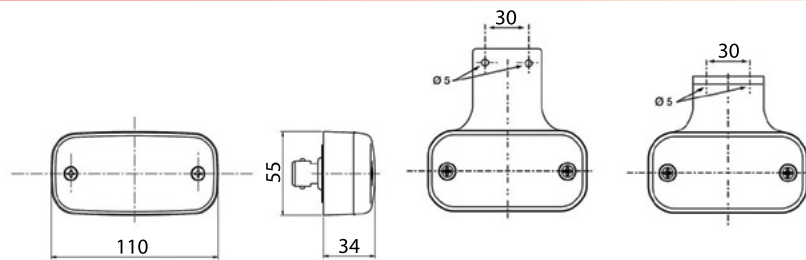

198060

Feux de position - Position lamps - Positionsleuchten

FE94/98



T4W



12/24V

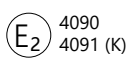

4090
4091 (K)



p. 192



p. 199

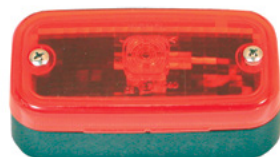
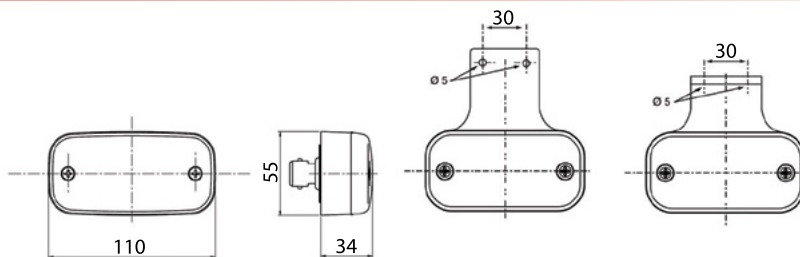

194310



PE



194250



194260



194270



D13876

JPT-2P-F



000176



094066



094056



001596



001586

FE87



C5W

12/24V

86711

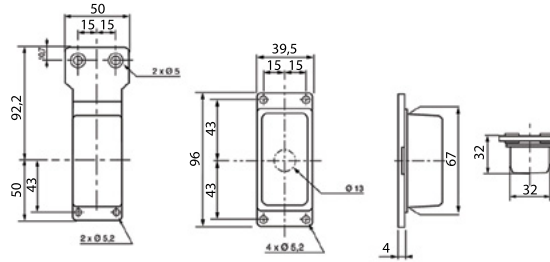

187130



187730



087030

cabochon - lens - Lichtscheibe

FE95



R5W

12/24V

5126

Affectations constructeurs
OE applications
Fahrzeugverwendung

HEULIEZ p. 39
IVECO BUS p. 54

140 mm x 65 mm x 30,5 mm



195060

FE85



R5W

24V

9036

175 mm x 68 mm x 52 mm



185030

semelle galbée - curved gasket - gewölbte Sockeldichtung



185050

semelle plate - flat gasket - flache Sockeldichtung

Feux de gabarits

End outline marker lamps

Begrenzungsleuchten



Tricolore - Tricolour - Dreifarbig

p. 207-209



Bicolore - Bicolor - Zweifarbig

p. 210-212



SS-2P-F

Type connecteur - Nb pins - Mâle ou Femelle
Connector type - Pins Nb - Male or Female
Steckertyp - Stifte Nb - männlich oder weiblich



Flashez le QR code pour plus d'infos
Scan the QR code for more info
Scannen Sie den QR-Code für weitere Informationen



Pièces détachées
Spare parts
Ersatzteile



Numéro d'homologation
Approval number
Zulassungsnummer

Feux de gabarits - End outline marker lamps - Begrenzungsleuchten

FA3 LED



LED

12/24V

ADR

E₂ 14010

* fils nus - naked cable extre-
mity - Kabellitze

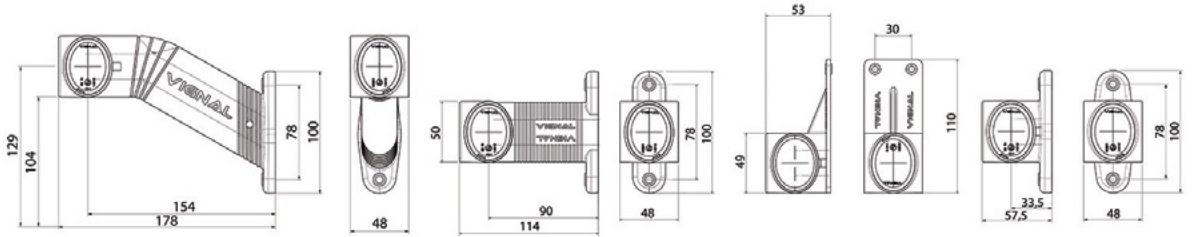

D14421* 1700 mm

D14427 1500 mm

gauche - left - links

CLICK-IN



D14422* 1700 mm

D14428 1500 mm

droit - right - rechts

CLICK-IN



D14423 1500 mm

gauche - left - links

POS-2P-F



Pour / For / Für LC8
D14423 - D14424 - D13875



D14424 1500 mm

droit - right - rechts

POS-2P-F



D14425 1500 mm

gauche - left - links

SS-2P-F



Pour / For / Für LC12T
D14425 - D14426 - D14655



D14426 1500 mm

droit - right - rechts

SS-2P-F



D14431* 1700 mm

D14429 1500 mm

gauche - left - links

CLICK-IN



D14432* 1700 mm

D14430 1500 mm

droit - right - rechts

CLICK-IN



D14031* 1700 mm

D14035 1500 mm

D14655 1500 mm

symétrique - symmetrical - symmetrisch

CLICK-IN

SS-2P-F



D14030* 1700 mm

D14034 1500 mm

D13875 1500 mm

symétrique - symmetrical - symmetrisch

CLICK-IN

POS-2P-F

FA3 LC12 LED



LED

12/24V

ADR

E₂ 14010



NEW



D14781
gauche - left - links

350 mm

SS-2P-F



D14782
droit - right - rechts

350 mm

SS-2P-F

FA3 LED LC8



LED

12/24V

ADR

E₂ 14010



D14038
gauche - left - links

500 mm

CLICK-IN



D14037
droit - right - rechts

500 mm

CLICK-IN



D14039
gauche - left - links

350 mm

POS-2P-F



D14040
droit - right - rechts

350 mm

POS-2P-F



Feux de gabarits - End outline marker lamps - Begrenzungsleuchten

DX LC8



W5W



24V



ADR

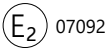

07092



D13034 500 mm
gauche - left - links **CLICK-IN**



D13035 500 mm
droit - right - rechts **CLICK-IN**



D12712 350 mm
gauche - left - links **POS-2P-F**



D12711 350 mm
droit - right - rechts **POS-2P-F**

DX



W5W



24V



ADR

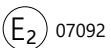

07092



D12430



D12429

1500 mm

CLICK-IN



D12428

1400 mm

CLICK-IN



D12471



D12473

K



D12472 1500 mm

Lampe non fournie - bulb
not included - nichte inklusiv
glühlampen

Feux de gabarits - End outline marker lamps - Begrenzungsleuchten

DX LED



90 mm x 50 mm x 180 mm

LED

12/24V

E₂₀ 020889
020890



D13624

filis nus - naked cable extremity - Kabellitze

DX



W5W

12/24V

ADR

E₂ 10035



* filis nus - naked cable extremity - Kabellitze

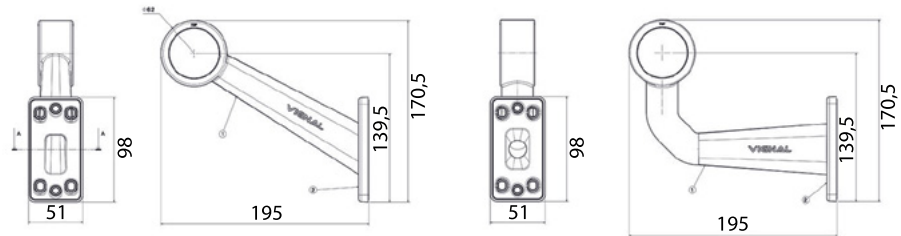

D10642 *



D10643 *



D10503

600 mm

CLICK-IN



D10800

R5W - 12/24V



D11899

500 mm

2 voies - 2 poles - 2 polig
Pour / For / Für LC8



POS-2P-F



611010



611020



D13277 350 mm



D11147 500 mm



610080 R5W

Lampe non fournie - bulb
not included - nichte inklusiv
glühlampen

Feux de gabarits - End outline marker lamps - Begrenzungsleuchten

FE12



LED

12/24V

E₂₄ 020078



* fils nus - naked cable extremity - Kabellitze

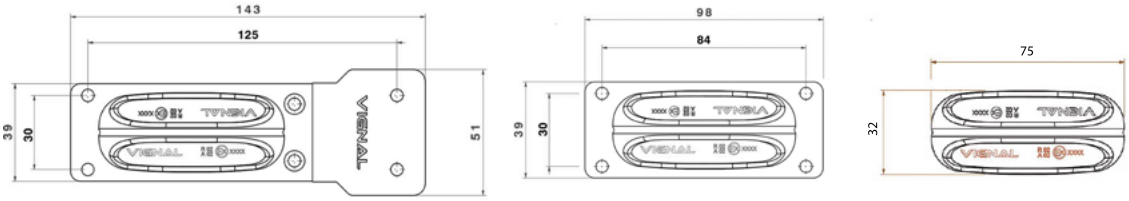

112110 * 1000 mm



112710 * 1000 mm



112120 * 1000 mm

112130 1500 mm **CLICK-IN**

112720 1500 mm **CLICK-IN**

112140 1500 mm **CLICK-IN**

FE88



C5W

12/24V

E₂ 88714

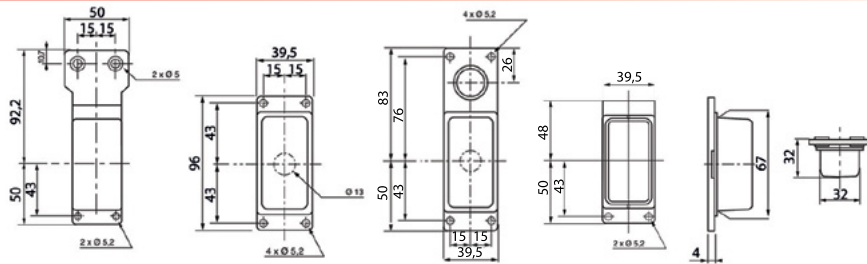

188110



188210



188010

pour presse-étoupe 000176
for o-ring 000176
für PG-Verschraubung 000176



188710



188610



188310



088010

cabochon - lens - Lichtscheibe



000176

FE81



107 mm x 47 mm x 41 mm



T4W



12/24V



181000



000086

Signalisation passive

Warning products

Warnmarkierungen



Plaques réfléchissantes - Reflective plates - Rückstrahlende Tafeln
p. 214



Bandes réfléchissantes - Reflective tapes - Reflektierende Streifen
p. 215



Catadioptres - Reflectors - Rückstrahler
p. 216



Triangle de présignalisation - Warning triangle - Warndreiecke
p. 217



Flashez le QR code pour plus d'infos
Scan the QR code for more info
Scannen Sie den QR-Code für weitere Informationen



Pièces détachées
Spare parts
Ersatzteile



Numéro d'homologation
Approval number
Zulassungsnummer

Plaques réfléchissantes - Reflective plates - Rückstrahlende Tafeln

R70



Camions / Cars et bus - Trucks / Coaches - LKW / Busse

1 x (130 x 1130)

2 x (130 x 565)

4 x (130 x 282)

E₁₁ 010002



* adhésif - adhesive - Selbstklebend



D14710 Alu 1 mm

D14706 Adhésif *

D14711 Alu 1 mm

D14707 Alu 1 mm

D14535 Plastique

Remorques - Trailers - Anhänger

1 x (195 x 1130)

2 x (195 x 565)

4 x (195 x 283)



D14712 Alu 1 mm

D14708 Adhésif *

D14713 Alu 1 mm

D14709 Alu 1 mm

D14536 Plastique

VC69



E R69

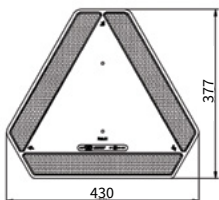

D14532

Véhicules lents - Slow vehicles - Langsame Fahrzeuge

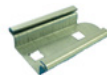

D14533



D14534

Bandes réfléchissantes - Reflective tapes - Reflektierende Streifen

R104



50 m x 50,8 mm

Surface rigide - Rigid support - Auf Festaufbauten

E13 0001



D12713



D12715



D12714

E13 0002

Surface souple - Curtain support - Für Plane



D13206



D13205



D13207

Carrés pré-espacés - segmented squares - vorgeschrittene Quadrate

BA



2 x 9 m x 141 mm



D14714 Cl. A: >80m

D14716 Cl. B: >500m

Classe 1 : ville et route nationale - town and trunk roads - Stadt und Landstrassen
Classe 2 : autoroutes et voies rapides - highways - Autobahnen und Schnellstrassen

2 x 45 m x 141 mm



D14715 Cl. A: >80m

Catadioptres - Reflectors - Rückstrahler

CA



Plastique - Plastic housing - Kunststoffgehäuse

Ø 61 mm	Ø 85 mm	57 mm x 39 mm
D14592	D14589	D14595
D14591	D14588	D14594
D14593	D14590	D14596
105 mm x 45 mm	105 mm x 45 mm - M4	90 mm x 39 mm
240366	241366	624036
240346	241346	624016
240356	241356	624026
adhésif - adhesive - Selbstklebend		adhésif - adhesive - Selbstklebend
159 mm x 159 mm x 159 mm		
D14587		

DSR



250 mm x 170 mm	250 mm x 170 mm
NEW	
D14990	D14991
Camions et poids lourds	Cars et bus

Triangle de présignalisation - Warning triangle - Warndreiecke

TRI



Affectations constructeurs
OE applications
Fahrzeugverwendung

RENAULT TRUCKS p. 86

SCANIA p. 116

VOLVO CONSTRUCTION p. 136

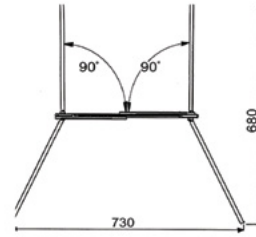
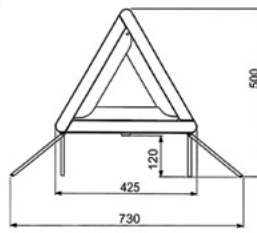

D10596
(564.VTO.VLG)

Phares homologués recul

Reverse approved work lights

Rückfahrlicht Zulassung Arbeitsscheinwerfer



DT-2P-M

Type connecteur - Nb pins - Mâle ou Femelle
Connector type - Pins Nb - Male or Female
Steckertyp - Stifte Nb - männlich oder weiblich



Flashez le QR code pour plus d'infos
Scan the QR code for more info
Scannen Sie den QR-Code für weitere Informationen



Pièces détachées
Spare parts
Ersatzteile



Numéro d'homologation
Approval number
Zulassungsnummer



Homologué ECE-R23
ECE-R23 Approved
Zulassen ECE-R23



Faisceau p. 301
Harness p. 301
Anschlusskabel siehe S. p. 301



Vitre en verre trempé
Tempered glass lens
Lichtsceibe aus gehärtetem Glas



Vitre en polycarbonate
Polycarbonate lens
Lichtsceibe aus Polycarbonat

SL 1000 R23



NEW



DT-2P-M

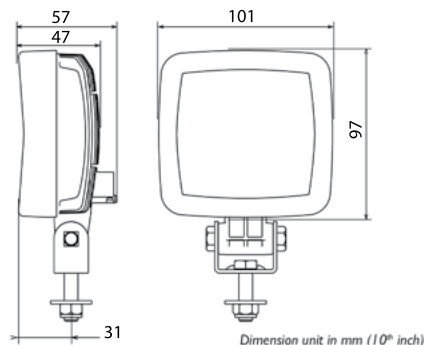

D14857
(A0787A711300)

LED

12/24V
14W

1000 Lumen

ADR

✓ R23 ✓ R10

E₂ 19140

IP69K

NEW



DT-2P-M



D14880
(A0787A712400)

Aluminium

RL 1500 R23



NEW



DT-2P-M

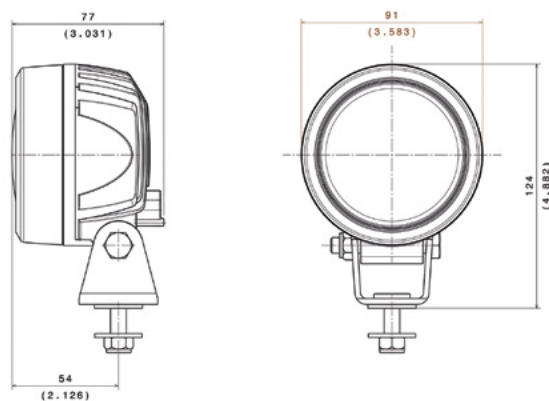

D14858
(A0787A7395C3)

LED

12/24V
20W

1500 Lumen

ADR

✓ R23 ✓ R10

E₂ 20078

IP69K

2963 R23



LED

12/24V
14W

1000 Lumen

✓ R23 ✓ R10

E11 7573

IP69K

D14555
(29.63.L23.C0V) 1000 mm

D14556 *
(29.63.L21.CDV)



* Interrupteur - switch - Schalter

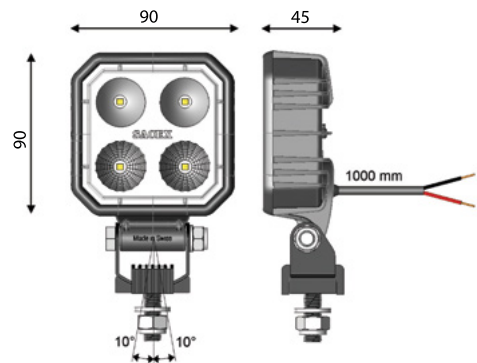

DT-2P-M

D14759
(29.63.L23.CDV)

NEW **D14811 ***
(29.63.L21.CDV)



* Interrupteur - switch - Schalter

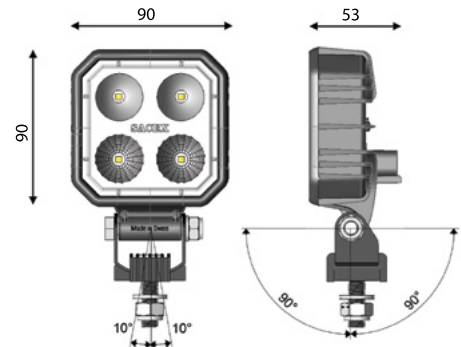

D14170 DT-2P-F

S H3 R23



H3/70W-24V

ADR

✓ R23

E2 R23-07089

IP69



DT-2P-M



D12390*
(A0782A736900)

Interrupteur - switch - Schalter

* lampe fournie - bulb included - inklusiv Glühlampen

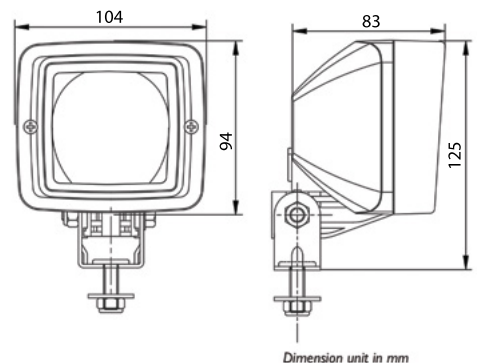

Dimension unit in mm

Phares de travail

Work lights

Arbeitsscheinwerfer



LED

p. 222-235



Halogene

p.236-237



DT-2P-M

Type connecteur - Nb pins - Mâle ou Femelle
Connector type - Pins Nb - Male or Female
Steckertyp - Stifte Nb - männlich oder weiblich



Flashez le QR code pour plus d'infos
Scan the QR code for more info
Scannen Sie den QR-Code für weitere Informationen



Pièces détachées
Spare parts
Ersatzteile



Faisceau p. 301
Harness p. 301
Anschlusskabel siehe S. p. 301



Vitre en verre trempé
Tempered glass lens
Lichtsceibe aus gehärtetem Glas



Vitre en polycarbonate
Polycarbonate lens
Lichtsceibe aus Polycarbonat

Phares de travail - Work lights - Arbeitsscheinwerfer



OE Original Parts



Nouveau! Éclairer plus loin et plus large
 CEM CISPR25 Classe 5 (la plus haute protection électromagnétique) - Load dump intégré
 New! Light up further and wider
 EMC CISPR25 Class 5 (the highest electromagnetic protection) - Load dump integrated
 Neu! Leuchten Sie weiter und weiter
 EMC CISPR25 Klasse 5 (der höchste elektromagnetische Schutz) - Load Dump integriert

SL 1000



NEW



DT-2P-M

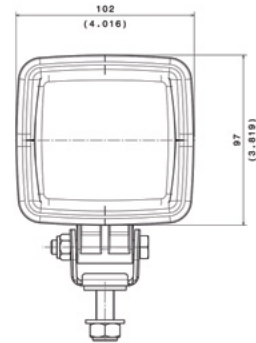
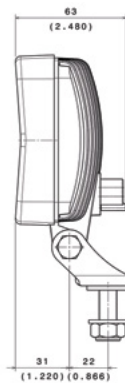

LED

12/24V
14W

1000 Lumen

IP69K

D14970
(A0787A742300)

NEW



DT-2P-M

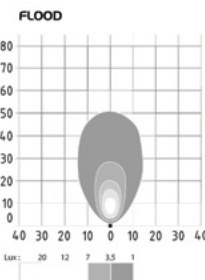

D14850
(A0787A710700)

SL 1500



NEW



DT-2P-M

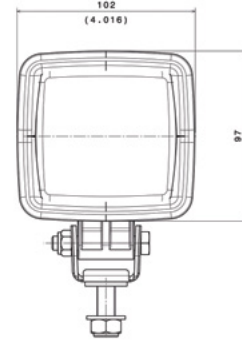
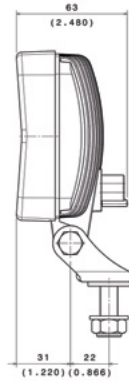

LED

12/24V
20W

1500 Lumen

IP69K

D14971
(A0787A742400)

NEW



DT-2P-M



FLOOD

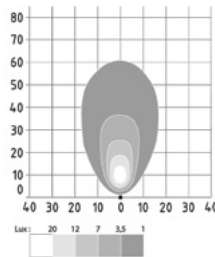

D14851
(A0787A710800)

SLA 2000



NEW



DT-2P-M

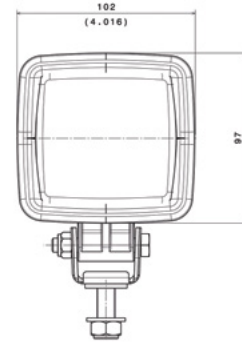
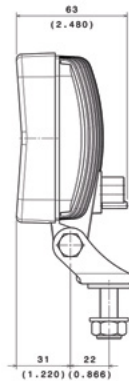

LED

12/24V
29W

2000 Lumen

IP69K

D14852
(A0787A710900)

Aluminium

NEW



DT-2P-M



FLOOD

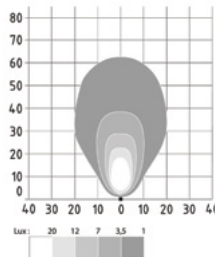

D14856
(A0787A711700)

Aluminium

SLA 2000 NO GLARE



NEW



DT-2P-M

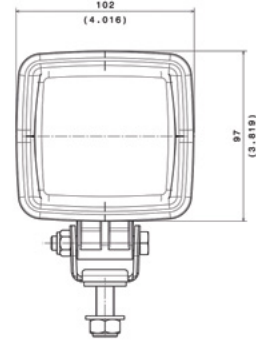
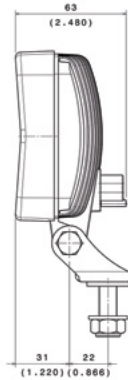

LED

12/24V
29W

2000 Lumen

IP69K

D14968
(A0787A7284C3)

Aluminium



N'éblouit ou n'aveugle pas - Éclaire la zone de travail
No blinding or dazzling - Illuminates work area
Kein Blenden - Beleuchtet den Arbeitsbereich



RL 1000



NEW



DT-2P-M

LED

12/24V
14W

1000 Lumen

IP69K

D14853
(A0187A711000)

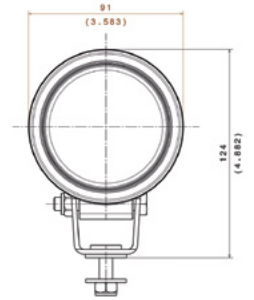
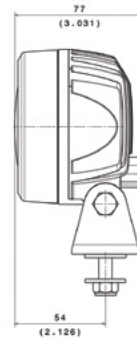
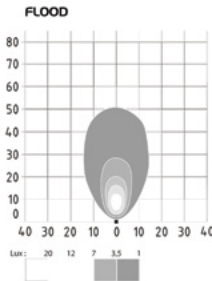

RL 1500



NEW



DT-2P-M

LED

12/24V
20W

1500 Lumen

IP69K

D14854
(A0187A711100)

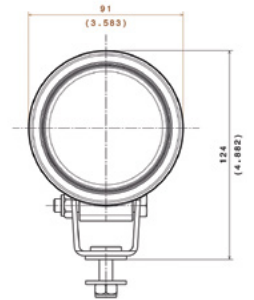
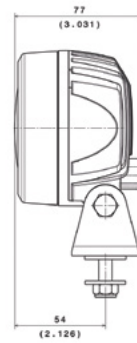
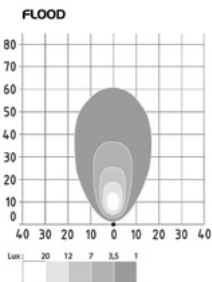

RLA 2000



NEW



DT-2P-M

LED

12/24V
29W

2000 Lumen

IP69K

D14855
(A0187A711200)

Aluminium

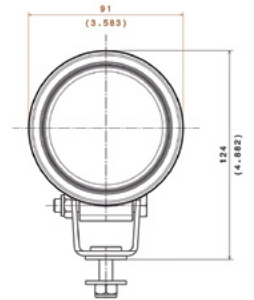
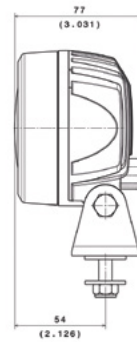
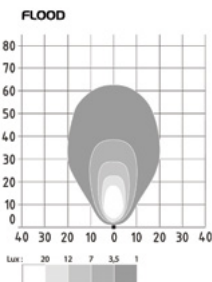

OLA 1000



NEW



DT-2P-M

LED

12/24V
14W

1000 Lumen

IP69K



D14965
(A0487A7402C3)

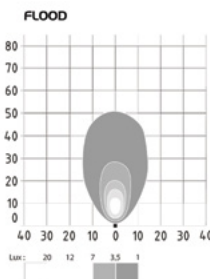

OLA 1500



NEW



DT-2P-M

LED

12/24V
20W

1500 Lumen

IP69K



D14966
(A0487A7406C3)

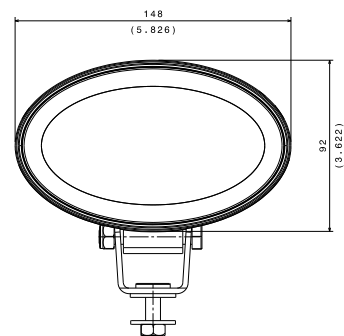
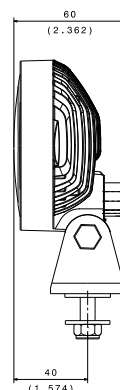
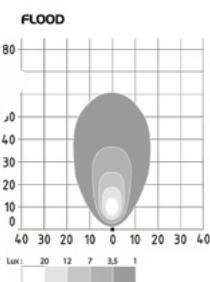

OLA 2000



NEW



DT-2P-M

LED

12/24V
29W

2000 Lumen

IP69K



D14967
(A0487A7200C3)

Aluminium

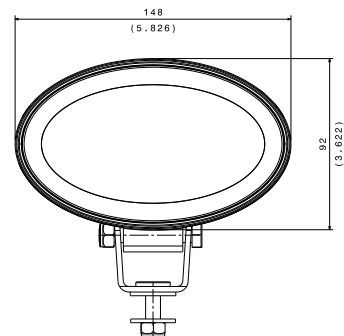
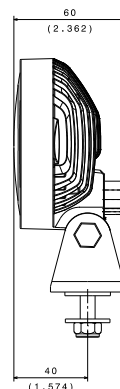
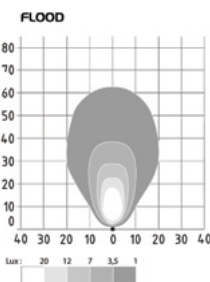

SHD 1000



DT-2P-M

LED

9/36V
11 W

1000 Lumen

IP69K

D14160
(A0787A656800)

Aluminium

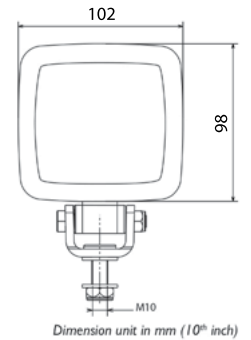
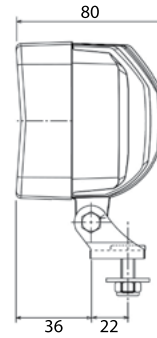
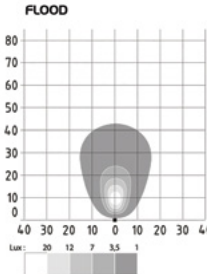

SHD 1200



DT-2P-M

LED

9/36V
20 W

1200 Lumen

IP69K

D14161
(A0787A656900)

Aluminium

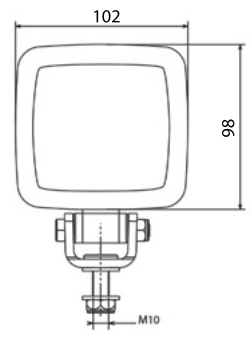
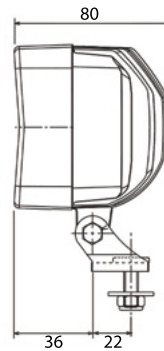
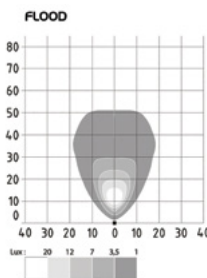

SHD 3000



DT-2P-M

LED

12/24-100V
38 W

3000 Lumen

IP69K

D14447
(A0787A682200)

Aluminium

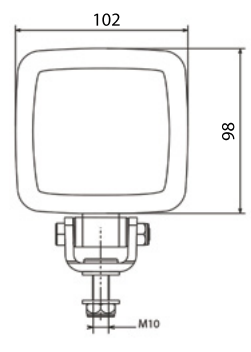
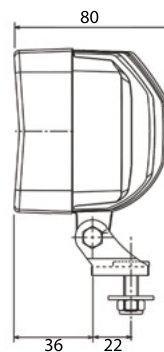
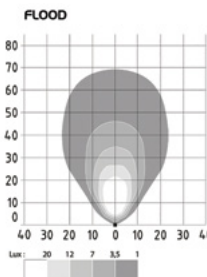

SHD 5000



DT-2P-M

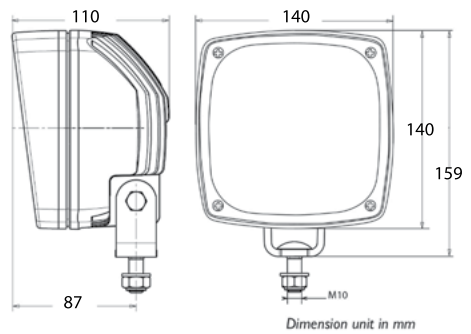

LED

12/24-100V
57 W

5000 Lumen

IP69K

D14387
(A0727A615900)
Aluminium

SHD 8000 LED



DT-2P-M

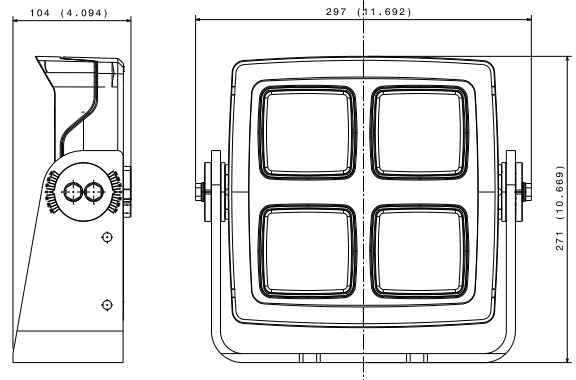

LED

12/24V
90 W

8000 Lumen

IP69K

Ref sur demande
P/N on request - Artikelnummer auf Anfrage



Feu de travail LED Heavy Duty modulaire
Modular Heavy Duty LED work light
Modularer LED Heavy Duty Arbeitsscheinwerfer



Long range

Flood



Long range
+ Indicator

Flood
+ Stop



BL15



LED

24V



E2 16007
10R-0516079

Affectations constructeurs
OE applications
Fahrzeugverwendung

CHEREAU p. 19
FRUEHAUF p. 35
LECAPITAINE p. 65
TROUILLET p. 123

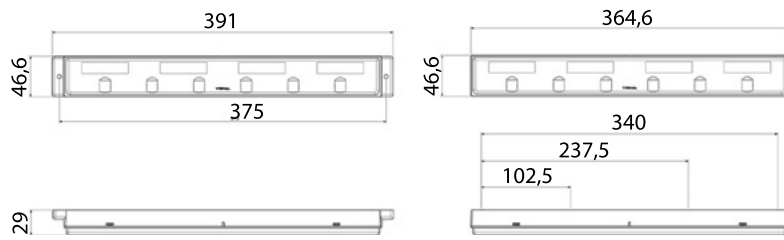

165020

gauche - left - links



DT04-4P-M



DTM06-4S-4P-F

Fixation par l'arrière
Back fixation
Rückenfixierung



165030

droit - right - rechts



165040

gauche - left - links

Fixation par l'avant
Front fixation
Frontfixierung



165050

droit - right - rechts



D14436

DT06-4S-4P-F



D14435

DTM04-4P-M

Indicateur de direction à défilement - feux de détresse flash
Dynamic indicator lights - warning lights
Dynamischer Blinker - blinkende Warnleuchte

Feu de travail 1200 Lumen
Work light 1200 Lumen
Arbeitsscheinwerfer 1200 Lumen

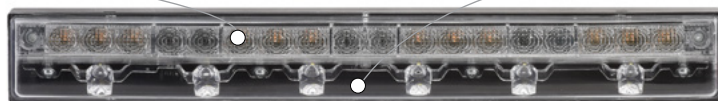

CARBONLUX



COMPACT - KOMPAKT
LEGER - LIGHT - LEICHT
TECHNO-RESINE CARBONE - TECHNO-RESIN CARBON - KARBONHARZ
OPTIQUE DOUBLE - DOUBLE OPTICS - DOPPELTE OPTIK

2960



D14540
(29.60.L00.C0V) 1000 mm

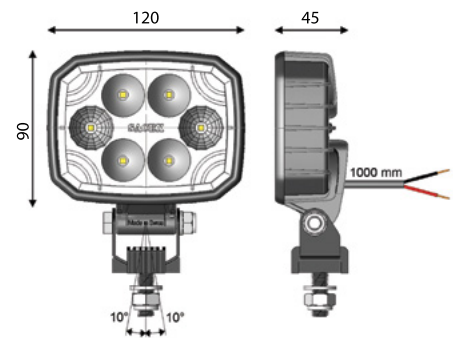

LED

10/30V
12 W

1500 Lumen

R10

IP69K



D14541
(29.60.L00.CDV)



DT-2P-M

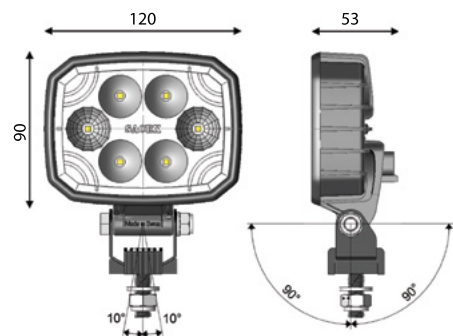

D14170 DT-2P-F

2961



LED

10/30V
12 W

1500 Lumen

R10

IP69K



D14542
(29.61.L00.C0V) 1000 mm



D14543
(29.61.L00.CDV)



DT-2P-M

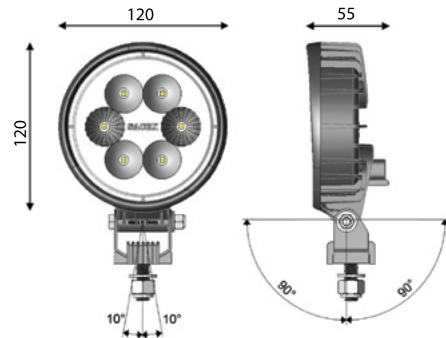
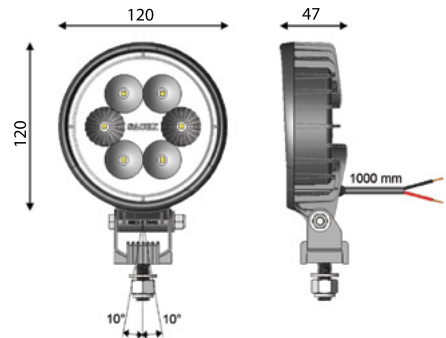

2962



LED

10/30V
12 W

1500 Lumen

R10

IP69K



D14544
(29.62.L00.C0V) 1000 mm



D14545
(29.62.L00.CDV)



DT-2P-M

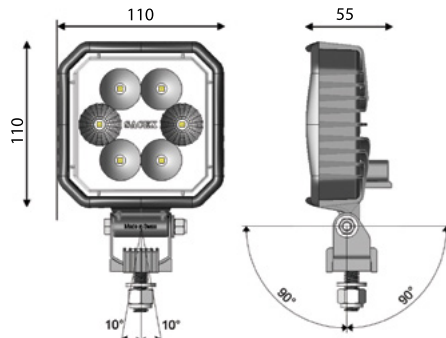
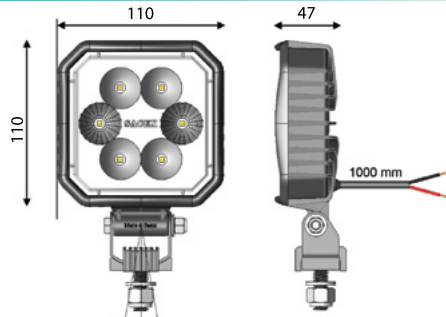

D14546
(29.62.LV0.CDV)

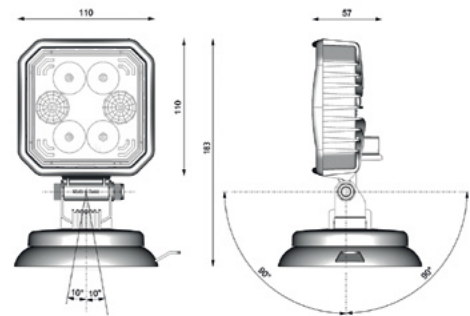

2963



LED

10/30V
9 W

1000 Lumen

R10

IP69K

PC



D14547
(29.63.L00.C0V) 1000 mm

PC



D14552
(29.63.LA0.C0V) 1000 mm

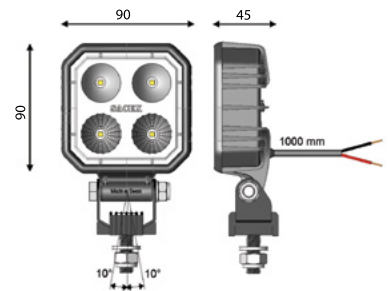

PC

FLOOD



D14553
(29.63.L0A.C0V) 1000 mm

PC

SPOT



D14554
(29.63.LSB.C0V) 1000 mm



PC



D14548
(29.63.L00.CDV)



DT-2P-M

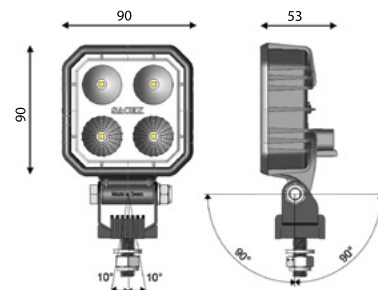

D14170 DT-2P-F

2963



LED

10/30V
9 W

1000 Lumen

R10

IP69K

*Interrupteur - switch - Schalter

PC



D14549 *
(29.63.LMI.COV) 1000 mm

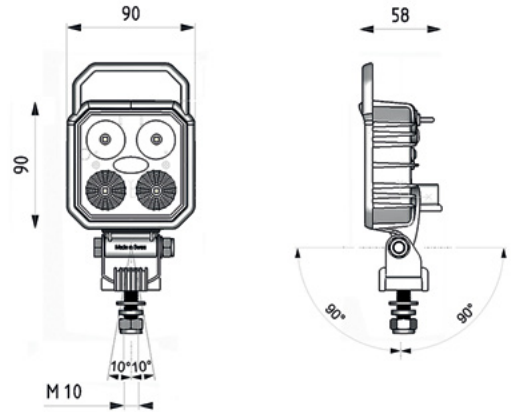

PC



D14550 *
(29.63.LVX.CDV)

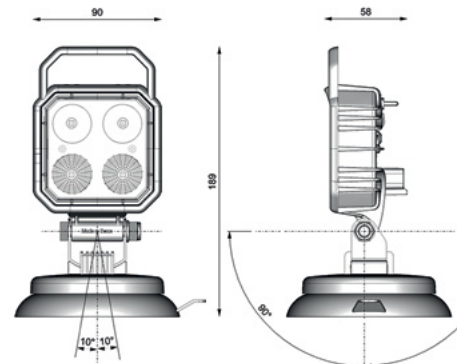

PC



D14551 *
(29.63.L7X.COV)

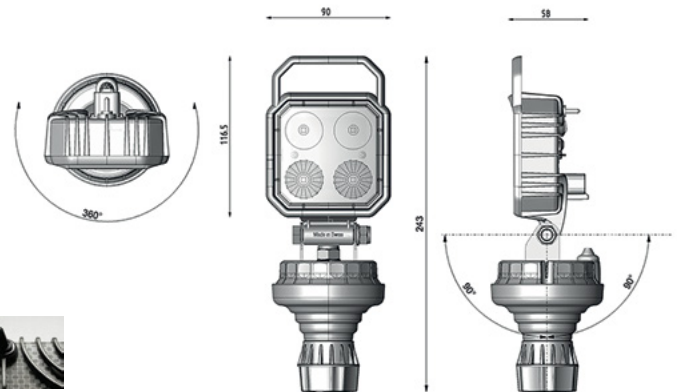

D14514

2964



LED

10/30V
12 W

2000 Lumen

R10

IP69K

PC



D14557
(29.64.L00.C0V) 1000 mm

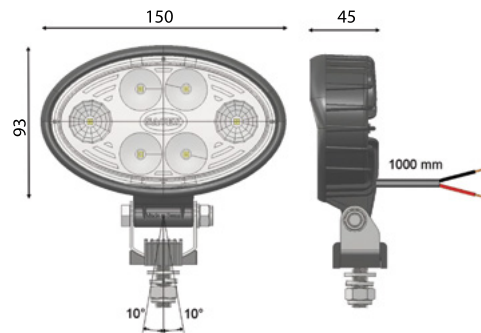

PC



D14558
(29.64.LMI.C0V)



Interrupteur - switch - Schalter

FTC



LED

12/24V
15 W

850 Lumen

IP69



High power 100%
Eco 30%
Flash SOS



D14191
batterie rechargeable
rechargeable battery
Akku

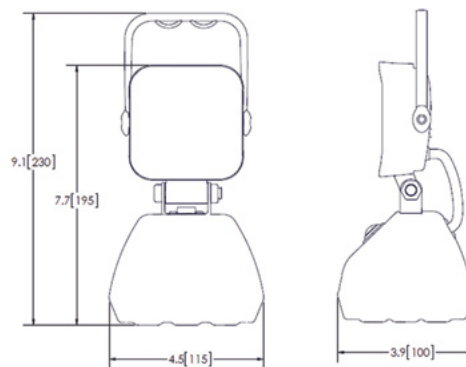

D14192
prise adaptateur AC - AC adapter plug
Wechselstromstecker

RC 850 LED



LED

10/30V
12 W

1500 Lumen

R10

IP69K

NEW



D14743 1000 mm

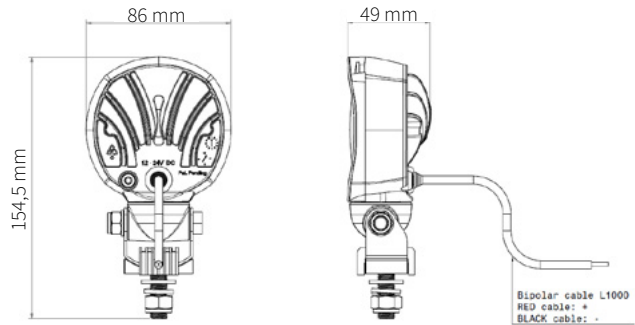

NEW



DT-2P-M

D14744

NEW

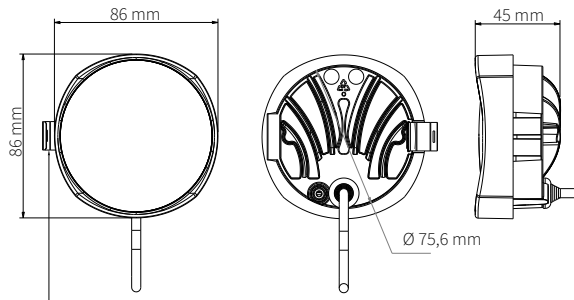

D14745

clippé - clipped - clip-befestigung



Compact (Ø 8,6 cm) et léger
Compact (Ø 8,6 cm) and light
Kompakt (Ø 8,6 cm) und leicht

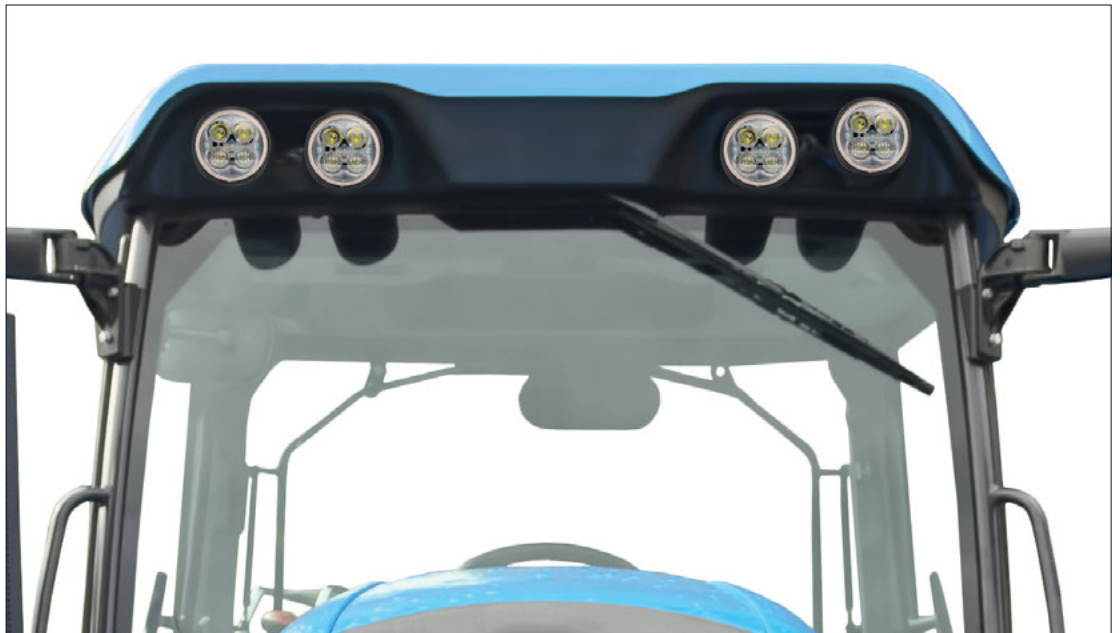

Phares de travail - Work lights - Arbeitsscheinwerfer

Q H3



H3/70W
12/24/36/48/80V



IP66



DT-2P-M



D14159
(A0782A736500)

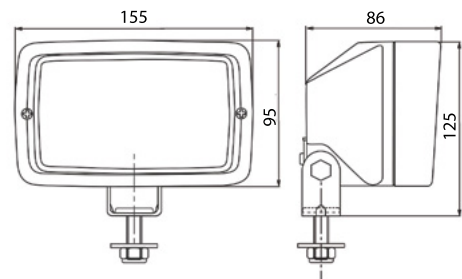

R H3



H3/70W
12/24/36/48/80V



IP66



DT-2P-M



D14654
(A0166A736400)

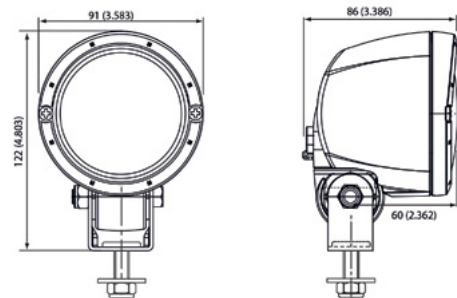

S H3



H3/70W-24V
H3/35W-24V ●



IP66



DT-2P-M



D14156
(A0782A736500)

D12488*
(A0782A736800) ●

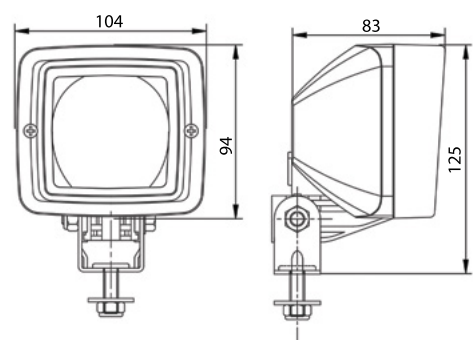

Dimension unit in mm

S H3

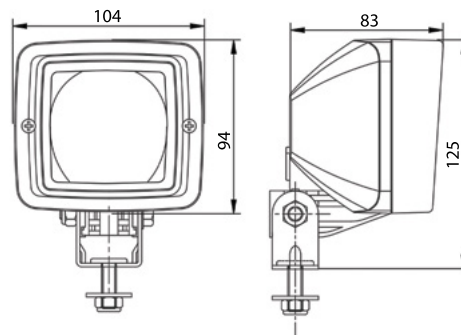

Dimension unit in mm

H3/70W-24V

IP66

Affectations constructeurs
OE applications
Fahrzeugverwendung

VOLVO TRUCKS p. 130

D12111*
(A0782A639700)

* lampe fournie - bulb included - inklusiv Glühlampen

S H3



DT-2P-M

H3/70W-24V

IP66

Affectations constructeurs
OE applications
Fahrzeugverwendung

RENAULT TRUCKS p. 89
SCANIA p. 116
VOLVO TRUCKS p. 134

D13019*
(A0782A563700)

* lampe fournie - bulb included - inklusiv Glühlampen

Éclairage de sécurité

Warning lights

Sicherheitsbeleuchtungen



DT-2P-M

Type connecteur - Nb pins - Mâle ou Femelle
Connector type - Pins Nb - Male or Female
Steckertyp - Stifte Nb - männlich oder weiblich



Vitre en verre trempé
Tempered glass lens
Lichtscheibe aus gehärtetem Glas



Flashez le QR code pour plus d'infos
Scan the QR code for more info
Scannen Sie den QR-Code für weitere Informationen

SHD BLUE RED

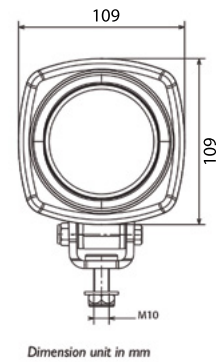
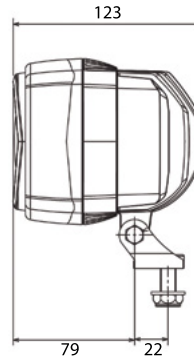

Dimension unit in mm

LED

12/24-100V
5W



IP69



D14249
(A0787A625500)



DT-2P-M

D14653
(A0787A677400)



DT-2P-M

D14250
(A0787A625600)



AMP-2P-M



QL LED



SPOT OU FLECHE - SPOT OR ARROW - SPOT
ODER PFEIL

LED

12/24-100V
7W



IP69



D14769
(A0737A702600)



DT-2P-M

D14770
(A0737A702700)



D14771
(A0737A702800)

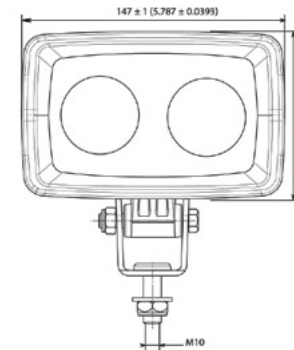
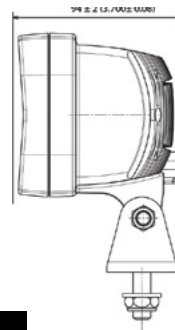

Dimension unit in mm (10th inc)

WARNING LINE



COMPACT - KOMPAKT



LED

12/24-80V
6W



IP67



D14357



D14358

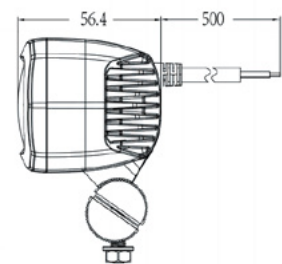
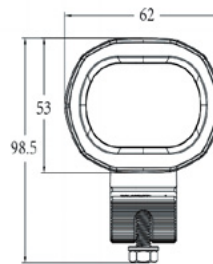

Phares de conduite

Headlights

Fahrlichter



NEW



DT-2P-M

Type connecteur - Nb pins - Mâle ou Femelle
Connector type - Pins Nb - Male or Female
Steckertyp - Stifte Nb - männlich oder weiblich



Flashez le QR code pour plus d'infos
Scan the QR code for more info
Scannen Sie den QR-Code für weitere Informationen



Pièces détachées
Spare parts
Ersatzteile

CHL 2 LED



LED

10/36V
50W High Beam
30W Low Beam

✓ ECE ✓ SAE

E R112 - R6 - R7

IP69K

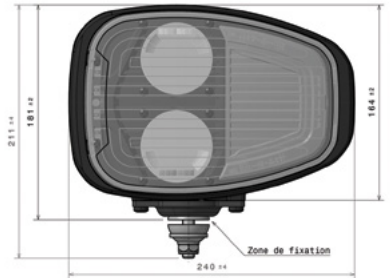
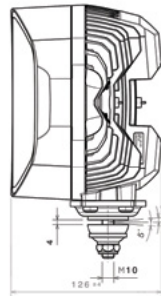

Feux de route - Feux de croisement - Indicateur de direction avant et latéral - Position
High beam - Low beam - Front and side direction indicator - Position
Fernlicht - Abblendlicht - Vorne und seite blinker - Position

NEW

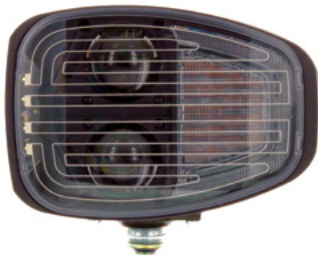

D14964
(A0831A7333N3)

gauche - left - links



DT04-6P-M

NEW

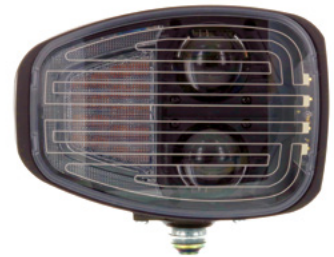

D14963
(A0831A7332N3)

droit - right - rechts



D14352
(A87005182400)

DT04-6P-F

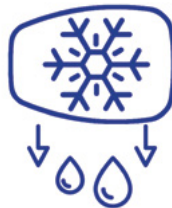

Nouveau! Technologie de dégivrage active et autonome
New! Active and autonomous de-icing technology
Neu! Aktive und autonome Enteisungstechnologie

✓ SAE



Ref sur demande
P/N on request - Artikelnummer auf Anfrage

CHL 1 LED



LED

12/24V
50W High Beam
48W Low Beam

✓ ECE

E R112 - R6 - R7

IP69

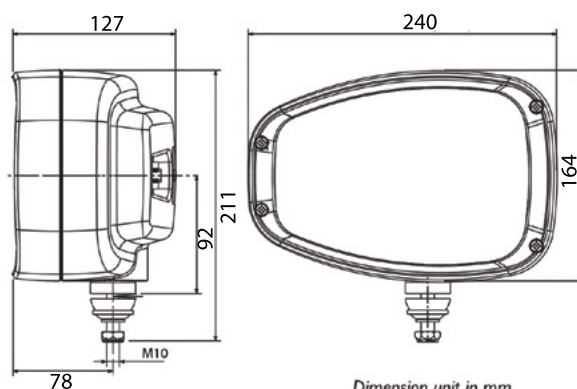

Feux de route - Feux de croisement - Indicateur de direction avant et latéral - Position
High beam - Low beam - Front and side direction indicator - Position
Fernlicht - Abblendlicht - Vorne und seite blinker - Position



D14324
(A0831A673200)

gauche - left - links



DT04-6P-M



D14325
(A0831A673300)

droit - right - rechts



D14352
(A87005182400)

DT04-6P-F

✓ SAE



Ref sur demande
P/N on request - Artikelnummer auf Anfrage

CHL1 H4

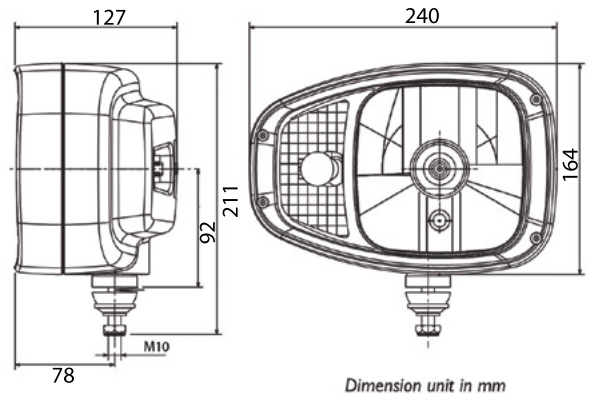
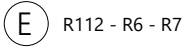

D14320
(A0830A673600) 12V

D14322
(A0830A673400) 24V

gauche - left - links



DT04-6P-M



D14321
(A0830A673700) 12V

D14323
(A0830A673500) 24V

droit - right - rechts



D14352
(A87005182400)

DT04-6P-F

CL1 LED OFR



LED

12/24V



5W Low Beam OFF Road

3W Turn light

2W Pilot light



IP69

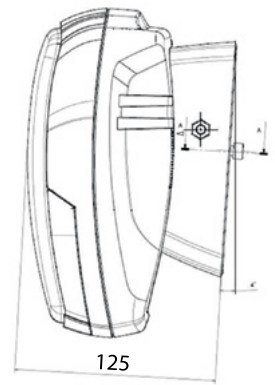
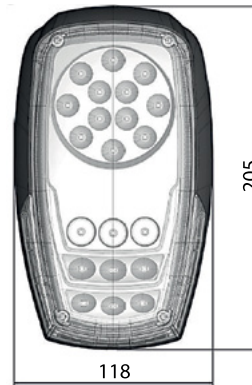

Feux de croisement - Indicateur de direction - Position
 Low beam - Direction indicator - Position
 Abblendlicht - Blinker - Position



D14649
 (A0801A699800)
 gauche - left - links



DT04-4P-M



D14649
 (A0801A699800)
 droit - right - rechts



D14436 **DT06-4S-4P-F**

Feux auxiliaires

Auxiliary lights

Zusatzscheinwerfer



DT-3P-M

Type connecteur - Nb pins - Mâle ou Femelle
Connector type - Pins Nb - Male or Female
Steckertyp - Stifte Nb - männlich oder weiblich



Flashez le QR code pour plus d'infos
Scan the QR code for more info
Scannen Sie den QR-Code für weitere Informationen

ALPHA 175 LED



NEW



DT-3P-M

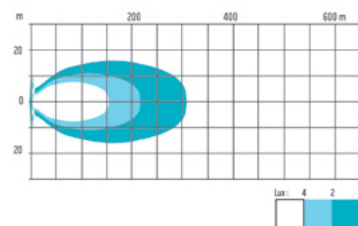
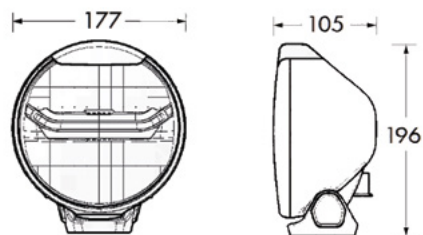

LED

10/33V
35W High beam
2,3W Position

4300 Lumen

* connecteur fourni -
connector included - inklusiv
anschlusstecker

D14167*
(A0342A699900)

ALPHA 225 LED



NEW



DT-3P-M

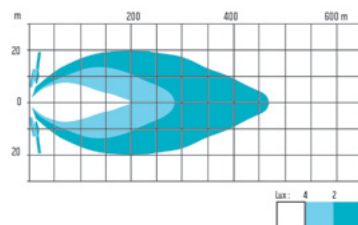
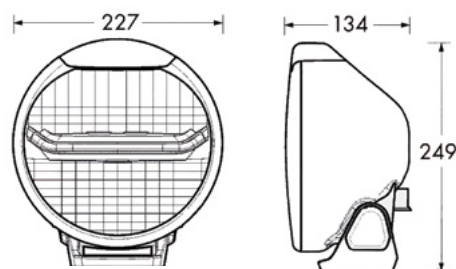

LED

10/33V
50W High beam
2,3W Position

6200 Lumen

* connecteur fourni -
connector included - inklusiv
anschlusstecker

D14993*
(A0332A745400)

ALPHA 225 LED



DT-3P-M

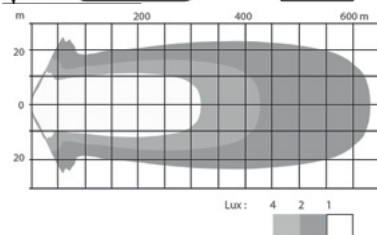
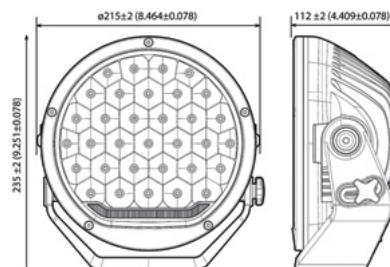

LED

10/33V
150W High beam
2,3W Position

8500 Lumen



IP67

* connecteur fourni -
connector included - inklusiv
anschlusstecker

D14673*
(A0342A699900)

ALPHA 225 XENON



 35W-D1S GEN5
24V
43 W

 16903

* lampe fournie - bulb included - inklusiv glühlampen

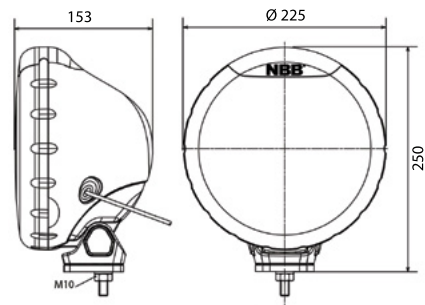

Dimension unit in mm

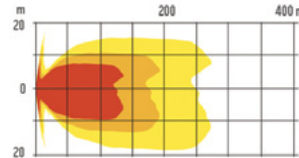

D14165*
(A0331A657300)

ALPHA 225



 H1-12/24V
70W Max

 16902

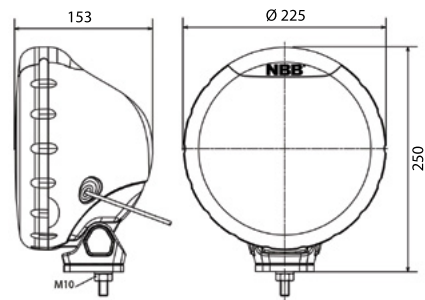

in mm

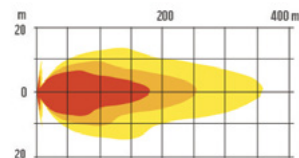

D14166
(A0330A657400)

Éclairage intérieur

Interior lights

Innenraum-Beleuchtungen



NEW



DT-2P-M

Type connecteur - Nb pins - Mâle ou Femelle
Connector type - Pins Nb - Male or Female
Steckertyp - Stifte Nb - männlich oder weiblich



Flashez le QR code pour plus d'infos
Scan the QR code for more info
Scannen Sie den QR-Code für weitere Informationen



Pièces détachées
Spare parts
Ersatzteile



Éclairage intérieur - Interior lights - Innenraum-Beleuchtungen

2250

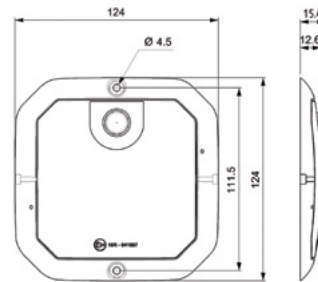
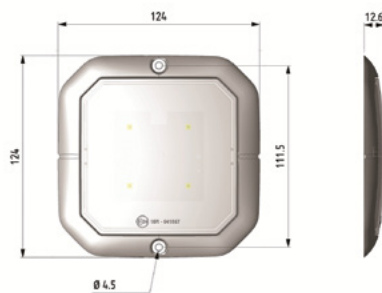

-  LED
-  10-30V
-  R10
-  IP69



-  > 4 m <
timer 5 min
-  500 Lumen

D14569
(22.50.LP4.VLG) 4 LEDS - PIR

Avec détecteur de mouvement et chaleur (capteur PIR) - with motion and heat detector (PIR sensor) - Mit Bewegungs- und Wärmemelder (PIR sensor)



-  > 4 m <
timer 5 min
-  500 Lumen

MASTER
D14598
(22.50.LP4.MSV) 4 LEDS - PIR

Avec détecteur de mouvement et chaleur (capteur PIR) - with motion and heat detector (PIR sensor) - Mit Bewegungs- und Wärmemelder (PIR sensor)



-  500 Lumen

D14567
(22.50.L04.VLG) 4 LEDS

Sans détecteur de mouvement et chaleur (capteur PIR) - without motion and heat detector (PIR sensor) - ohne Bewegungs- und Wärmemelder (PIR sensor)



-  750 Lumen

D14568
(22.50.L06.VLG) 6 LEDS

Sans détecteur de mouvement et chaleur (capteur PIR) - without motion and heat detector (PIR sensor) - ohne Bewegungs- und Wärmemelder (PIR sensor)

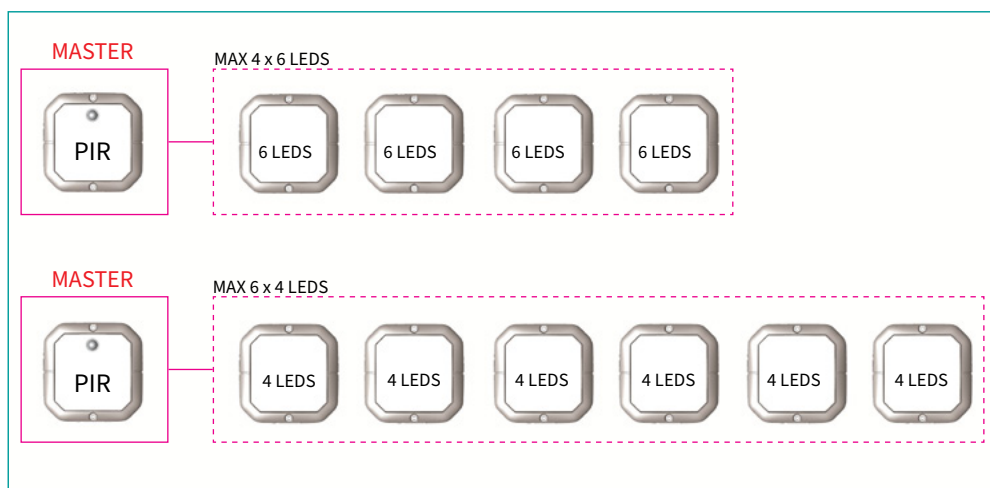

Exemple de montage Maître (PIR) + Esclaves - Assembly suggestion
Master (PIR) + Slaves - Montagebeispiel Meister (PIR) + Sklave

Éclairage intérieur - Interior lights - Innenraum-Beleuchtungen

RCL 1200

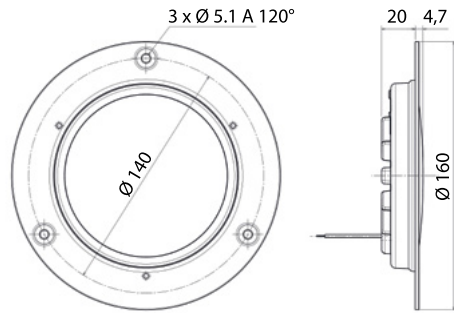

LED



9-30V



1200 Lumen



IP67

filš nus - naked cable extremity - Kabellitze



300010

6 LEDS

NEW



300000

6 LEDS

chromé - chrome-plated - verchromt

FE02

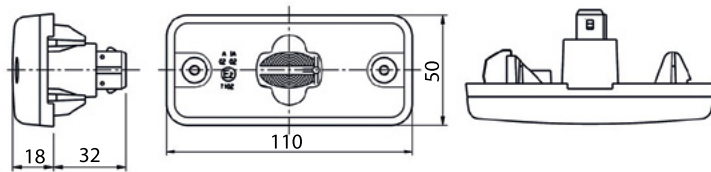

W5W - 12/24V



E₂ 7102



102200

K

clippé - clipped - clip-befestigung



D13876

JPT-2P-F



001726

Gyrophares Beacons Rundumkennleuchten



LED
p. 252-259



Halogene
p. 260-263



 Montage sur tige
DIN pole mounting
Für Aufteckrohr



Flashez le QR code pour plus d'infos
Scan the QR code for more info
Scannen Sie den QR-Code für weitere Informationen



Accessoires p. 263
Accessories p. 263
Zubehör S. p. 263

 Fixation à visser
Screw mounting
Schraubbefestigung



Indice de protection IP - solides/liquides
IP ingress protection - solids/liquids
IP Schutzfaktor - Fremdkörper/Wasser

 Magnétique
Magnetic
Magnetfuß



Pièces détachées
Spare parts
Ersatzteile

 LED Rotatif
LED Rotative
Rotierend LED



Homologation circulation réseau routier public
Approval circulation on public road network
Genehmigung des öffentlichen Straßennetzes

 LED à éclats
LED Flash
Blitze LED



Homologation CEM - compatibilité électromagnétique
EMC approval - Electromagnetic Compatibility
EMV zulassung - Elektromagnetische Verträglichkeit

 Polycarbonate
Polycarbonate
Polycarbonat

Gyrophares - Beacons - Rundumkennleuchten

ATLAS



LED

10/30V
11 W - 17 W

✓ R65 ✓ R10

IP6K9K



Affectations constructeurs
OE applications
Fahrzeugverwendung

CLAAS p. 22
DE BUF p. 29
HYUNDAI CE p. 42
MAN p. 70

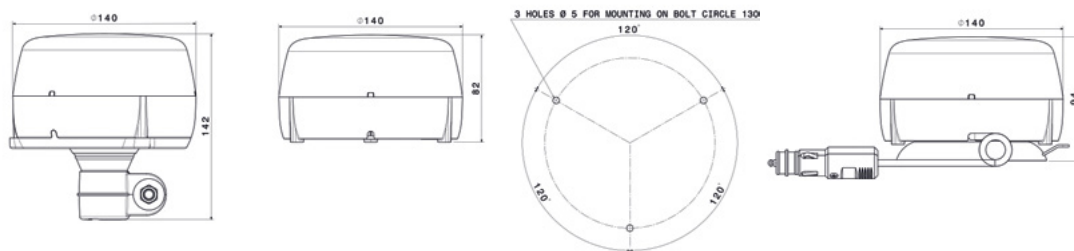

212420



CEM Class 5

NEW



212400



CEM Class 3
CLAAS p. 22



212470



CEM Class 5



212120



212160



filis nus - naked cable extremity - Kabellitze
CEM Class 5



212020

CEM Class 5
MAN p. 70



POS-2P-M



212030

CEM Class 5
MAN p. 70



POS-2P-M



Durée de vie optimale - Gestion thermique des Leds - CEM Classe 5
Optimum service life - LED thermal management - EMC Class 5
Optimale Lebensdauer - LED-Thermomanagement - EMV-Klasse 5



D13879

POS-2P-F



Gyrophares - Beacons - Rundumkennleuchten

ATLAS



LED

10/30V
11 W - 17 W

R65 R10

IP69



Affectations constructeurs
OE applications
Fahrzeugverwendung

MERCEDES p. 76
RENAULT TRUCKS p. 86
SAME p. 114
VOLVO p. 130

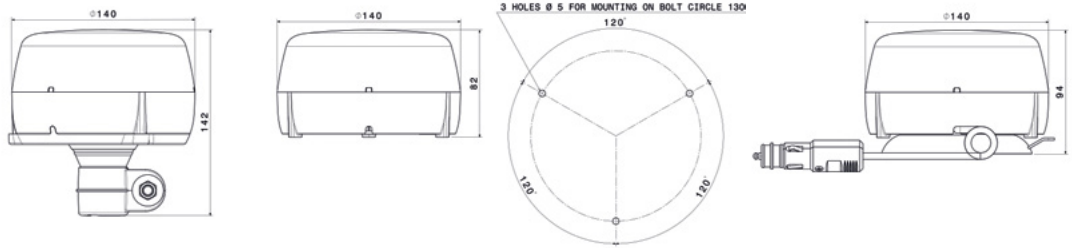

NEW



212730

CEM Class 5
VOLVO p. 130



TYCO MCON-2P-M



212170

CEM Class 5
fils nus - naked cable extremity - Kabellitze



NEW



212710

CEM Class 5
MERCEDES p. 76



MQS-2P-M



212010

CEM Class 4
MERCEDES p. 76



KOSTAL-2P-M

NEW



212740*

CEM Class 5
RENAULT TRUCKS p. 86



AMP-4P-F

NEW



212750*

CEM Class 5
RENAULT TRUCKS p. 86



AMP-4P-F

*212740 - 212750
Disponible en 09/2021
Available in 09/2021
Verfügbar in 09/2021



212520



212560

CEM Class 5



212570

CEM Class 5



Gyrophares - Beacons - Rundumkennleuchten

PEGASUS



LED

10/30V
9 W

R65 R10



* Multifunction - Multifunktions
** Rotative - Rundumlauf

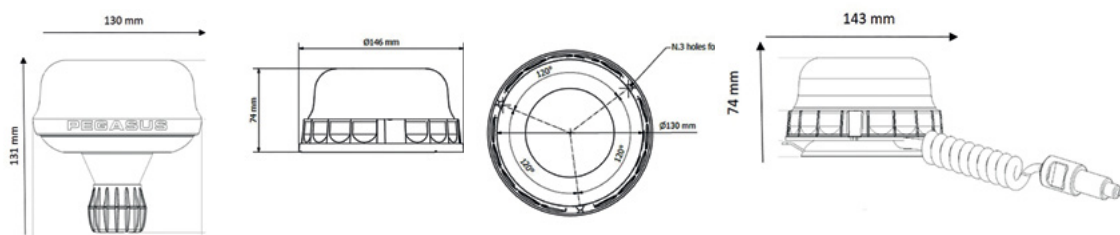

3 Types de flash homologués ECE R65
3 Flash patterns certified ECE R65
3 Blitzarten ECE R65 zugelassen



FLEXI

D14501
(21.50.L75.5V8) Multifonction*

D14725
(21.50.L75.3V8) Rotatif**



D14500
(21.50.L35.5V8) Multifonction*

D14724
(21.50.L35.3V8) Rotatif**



D14502
(21.50.LV5.5V8) Multifonction*

D14726
(21.50.LV5.3V8) Rotatif**



D14503
(21.50.811.MUV) Multifonction*
cabochon - lens - Lichtscheibe



FLEXI

D14757
(21.50.L75.51V) Multifonction*



D14756
(21.50.L35.51V) Multifonction*



D14758
(21.50.LV5.51V) Multifonction*



D14747
(21.50.201.MUV) Multifonction*
cabochon - lens - Lichtscheibe

GALAXY LED



LED

10/30V
9 W

✓ R65 ✓ R10

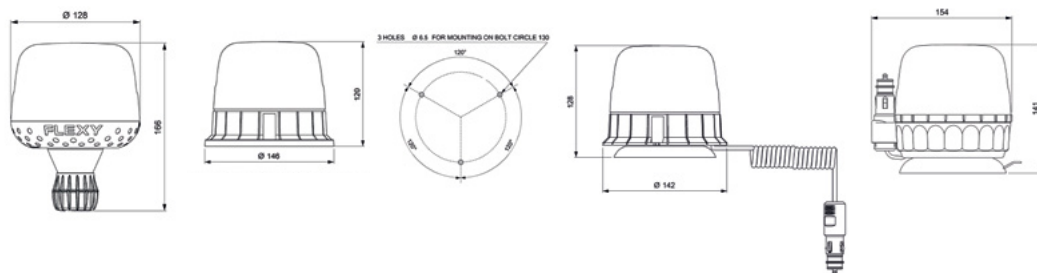

FLEXI

D14488
(21.49.L75.3V8)



D14487
(21.49.L35.3V8)



D14489
(21.49.LV5.3V8)



D14493
(21.49.L75.1V8)



D14492
(21.49.L35.1V8)



D14494
(21.49.LV5.1V8)



D14490
(21.49.LR5.3V8)



D14495
(21.49.LR5.1V8)



D14755
(21.49.LR5.11V)



ROLL CABLE

ROLL CABLE



FLEXI

D14753
(21.49.L75.11V)



D14752
(21.49.L35.11V)



D14754
(21.49.LV5.11V)



D14491
(2149.815.RTV)



D14496
(2149.815.LMV)



cabochon - lens - Lichtscheibe

D14779
(21.49.801.VLG)



cabochon - lens - Lichtscheibe

Gyrophares - Beacons - Rundumkennleuchten

VENUS LED

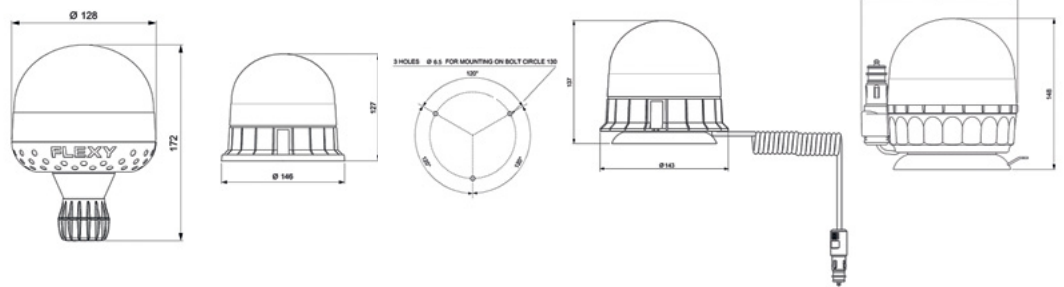

LED

10/30V
9 W

✓ R65 ✓ R10



DOUBLE FLASH
DOPPELBLITZ



D14728
(21.43.L75.2V8)



D14727
(21.43.L35.2V8)



D14729
(21.43.LV5.2V8)



D14730
(21.43.LR5.2V8)



D14731
(21.43.815.VLG)

cabochon - lens - Lichtscheibe

VEGA LED

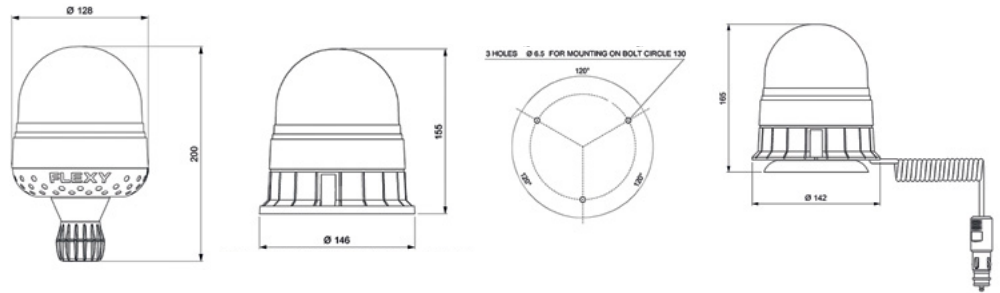

LED

10/30V
9 W

✓ R65 ✓ R10



D14508
(21.87.L75.3V8)



D14507
(21.87.L35.3V8)



D14509
(21.87.LV5.3V8)



D14510
(21.87.815.RTV)

cabochon - lens - Lichtscheibe

TAURUS LED



LED

10/30V
9 W

✓ R65 ✓ R10

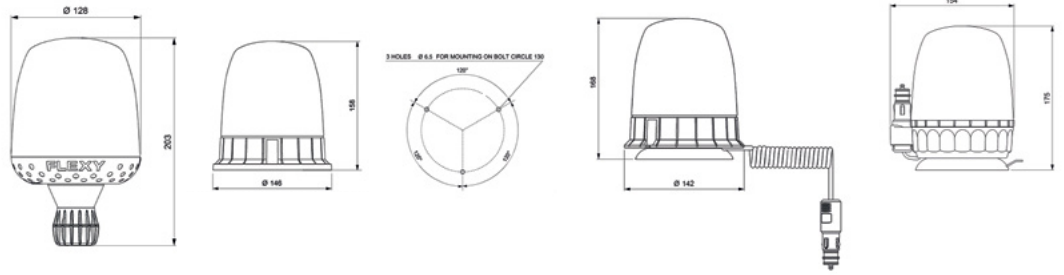

FLEXI

D14483
(21.48.L75.3V8)



D14482
(21.48.L35.3V8)



D14485
(21.48.LV5.3V8)



D14484
(21.48.LR5.3V8)

ROLL CABLE

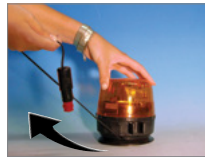

D14734
(21.48.LR5.15V)

ROLL CABLE



FLEXI

D14733
(21.48.L75.15V)



D14732
(21.48.L35.15V)



D14735
(21.48.LV5.15V)



D14486
(2148.815.RTV)

cabochon - lens - Lichtscheibe



D14736
(2148.855.LMV)

cabochon - lens - Lichtscheibe

SATURNELLO LED



LED

10/30V
9 W

✓ R65 ✓ R10

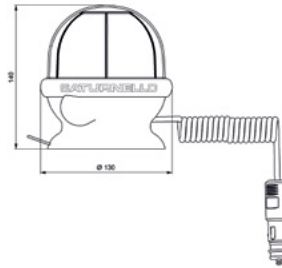
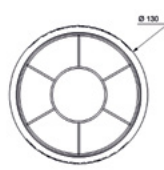

FLEXI

D14737
(21.88.L85.3V8)



D14738
(21.88.LV5.3V8)



D14739
(21.88.815.VLG)

cabochon - lens - Lichtscheibe

MINI SATURNELLO LED



LED

10/30V
9 W

✓ R65 ✓ R10

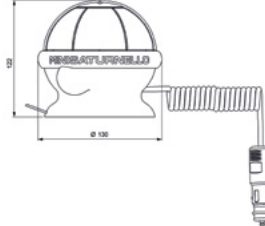

FLEXI

D14740
(21.83.L85.3V8)



D14741
(21.83.LV5.3V8)



D14742
(21.83.815.VLG)

cabochon - lens - Lichtscheibe

Gyrophares - Beacons - Rundumkennleuchten

PUCK



LED

10/30V
3,5 W

R10

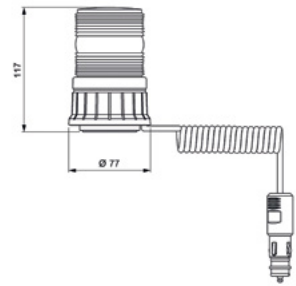
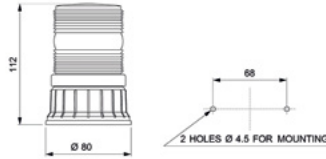
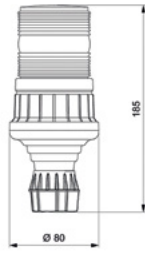

FLEXI

D14453
(21.38.L75.2VL)



D14451
(21.38.L35.2VL)



D14452
(21.38.LM5.2VL)



COMPACT - KOMPAKT



FRESNEL



LED

10/110V
3,5 W

R10

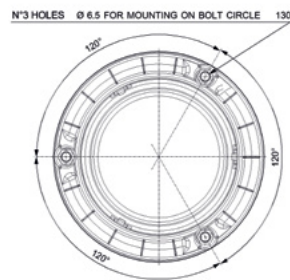
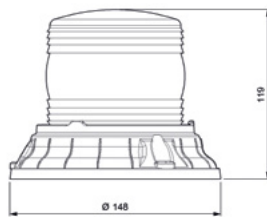

D14746
(21.37.L35.2VL)

Gyrophares - Beacons - Rundumkennleuchten

GALAXY



H21W



12/24V
23W



lampes 12/24V fournies
- 12/24V bulbs included -
inklusive Glühlampen 12/24V

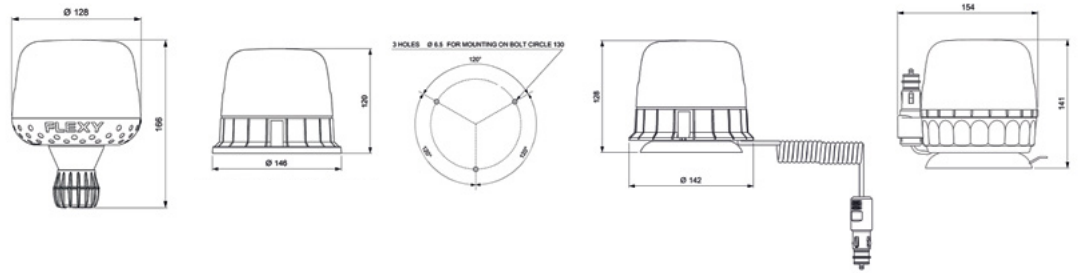

FLEXI

D14749
(21.49.H75.VLG)



D14748
(21.49.H35.VLG)



D14750
(21.49.HV5.VLG)



D14751
(21.49.HR5.VLG)



ROLL CABLE



D14778
(21.49.811.VLG)

cabochon - lens - Lichtscheibe

VENUS



H21W



12/24V
23W



lampes 12/24V fournies
- 12/24V bulbs included -
inklusive Glühlampen 12/24V

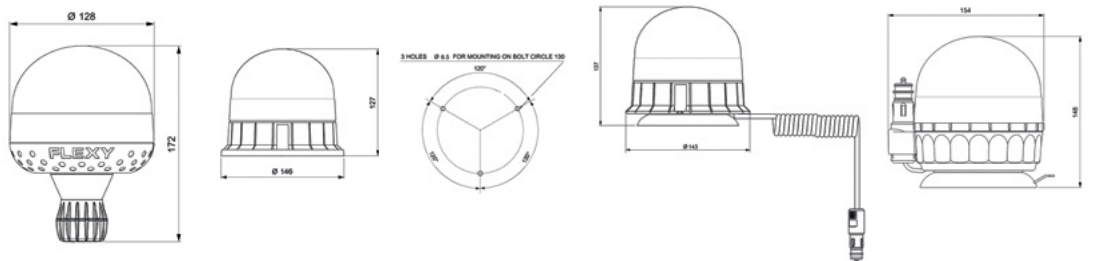

FLEXI

D14463
(21.43.H65.VLG)



D14462
(21.43.H35.VLG)



D14464
(21.43.HV5.VLG)



D14465
(21.43.HR5.VLG)



ROLL CABLE



D14466
(21.43.811.VLG)

cabochon - lens - Lichtscheibe

Gyrophares - Beacons - Rundumkennleuchten

TAURUS



H21W

12/24V
23W



lampes 12/24V fournies - 12/24V bulbs included - inklusiv Glühlampen 12/24V

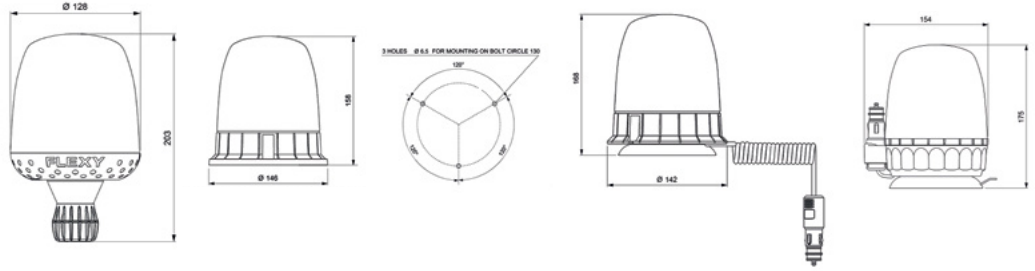

FLEXI

D14470
(21.48.H75.VLG)



D14467
(21.48.H35.VLG)



D14468
(21.48.HV5.VLG)



D14469
(21.48.HR5.VLG)



ROLL CABLE



D14471
(21.48.811.VLG)

cabochon - lens - Lichtscheibe

VEGA



H1

12/24V
55-70W



lampes 12/24V fournies - 12/24V bulbs included - inklusiv Glühlampen 12/24V

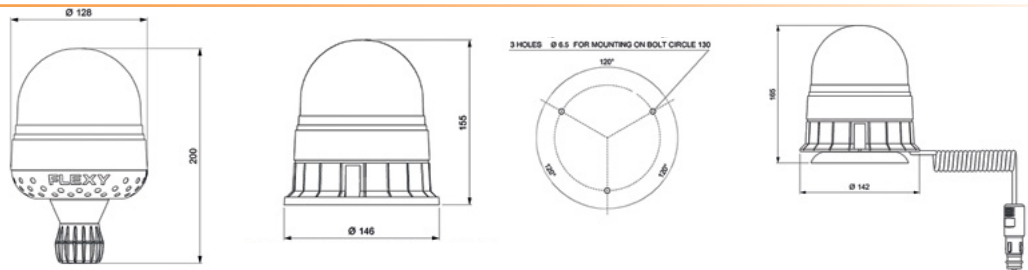

D14479
(21.87.T75.VLG)



D14477
(21.87.T35.VLG)



D14478
(21.87.TV5.VLG)



D14480
(21.87.811.VLG)

cabochon - lens - Lichtscheibe

Gyrophares - Beacons - Rundumkennleuchten

SATURNE



H1



12/24V
55-70W



lampes 12/24V fournies
- 12/24V bulbs included -
inklusive Glühlampen 12/24V



FLEXI

D14475
(21.82.T85.VLG)

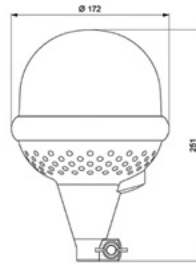

D14476
(21.82.811.VLG)

cabochon - lens - Lichtscheibe

GOUTTE



10/30V
9 W



D14481
(21.35.LMV.358)

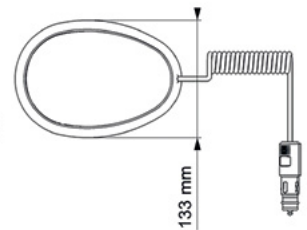
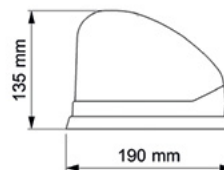

H1



12V



D14454
(21.35.010.TVL)



D14455
(21.35.050.TVL)



D14456
(21.35.811.VLG)

cabochon - lens - Lichtscheibe



D14457
(21.35.851.VLG)

cabochon - lens - Lichtscheibe



Exemple de montage - Assembly suggestion - Montagebeispiel



D14514
(21.92.000.VLG)

tige avec support central - socket with central clamp - Aufsteckrohr mit zentralem Tragbuegel
ISO 4148/4165



D14513
(21.91.000.VLG)

tige à visser - socket to be screwed Aufsteckrohr zum Anschrauben
ISO 4148/4165

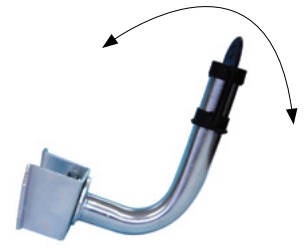

D14515
(21.97.005.VLG)

tige articulée 360° - 360° rotating socket - Bewegbarer Aufsteckrohr 360°
ISO 4148/4165



D14511
(21.76.282.VLG)

semelle plate - flat gasket - Flache Sockeldichtung



D14512
(21.76.283.VLG)

semelle inclinée - tilted gasket - Gekippte Sockeldichtung



Exemple de montage - Assembly suggestion - Montagebeispiel



D14565 H21W 12V BAY9s
(90.16.025.VLG)

D14566 H21W 24V BAY9s
(90.16.026.VLG)

Rampes lumineuses

Lightbars

Warnbalken



NEW

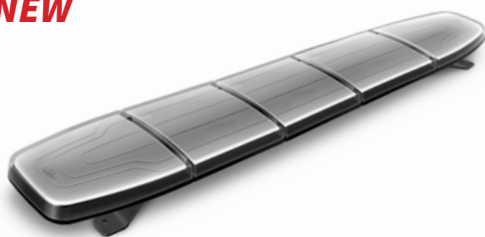

Fixation à visser
Screw mounting
Schraubbefestigung



Magnétique
Magnetic
Magnetfuss



Polycarbonate
Polycarbonat
Polycarbonat



Flashez le QR code pour plus d'infos
Scan the QR code for more info
Scannen Sie den QR-Code für weitere Informationen



IP6K9K

Indice de protection IP - solides/liquides
IP ingress protection - solids/liquids
IP Schutzfaktor - Fremdkörper/Wasser



Pièces détachées
Spare parts
Ersatzteile



R65

Homologation circulation réseau routier public
Approval circulation on public road network
Genehmigung des öffentlichen Straßennetzes



R10

Homologation CEM - compatibilité électromagnétique
EMC approval - Electromagnetic Compatibility
EMV zulassung - Elektromagnetische Verträglichkeit

STELLAR



LED

10/36V

✓ R65

✓ R10

✓ SAE



IP6K9K

NEW

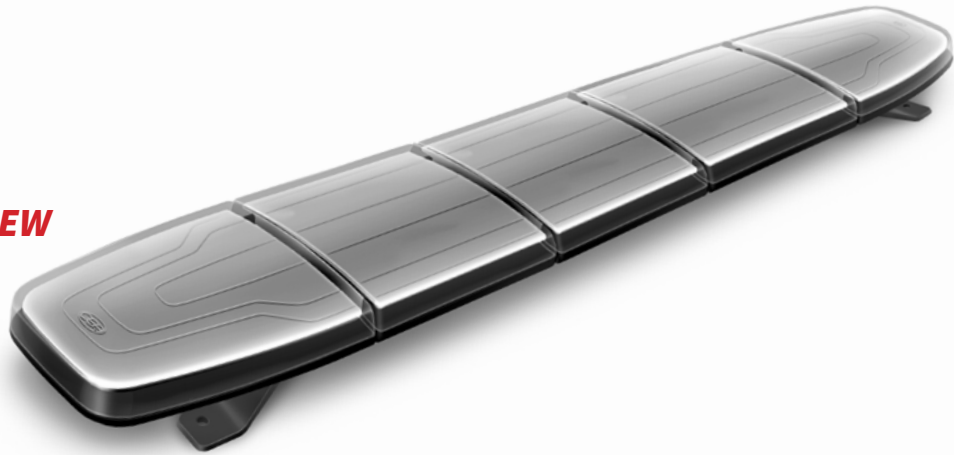

Modulaire et extra-plat - Circuit électronique plat - aucun câble intérieur
Modular and extra-flat - Flat PCB - no internal cables
Modular und extra flach - Flach-PCB - Internen Kabelfrei



Rampes lumineuses - Lightbars - Warnbalken

STELLAR



NEW

LED



10/36V



IP6K9K

Câble fils nus - naked cable
extremity - Kabellitze

* partie centrale opaque
pour lettrages - opaque
central part for lettering -
undurchsichtiger Mittelteil
zur Beschriftung



D23300*
(2370R35050)

950 mm



D23301
(2370R35000)

950 mm

-> Petits véhicules utilitaires, voirie
-> Light vans or community vehicles
-> Klein Nutzfahrzeuge, Gemeinschafts Fahrzeuge



D23400*
(2371R35050)

1250 mm



D23401
(2371R35000)

1250 mm

-> Véhicules utilitaires, voirie
-> Vans or community vehicles
-> Nutzfahrzeuge, Gemeinschafts Fahrzeuge



D23500*
(2372R35055)

1550 mm



D23501
(2372R35000)

1550 mm

-> Camions (3,5t à 19t)
-> Trucks (3,5t to 19t)
-> Lastkraftwagen (3,5t bis 19t)



D23600*
(2373R35005)

1850 mm



D23601
(2373R35000)

1850 mm

-> Camions (19t à 44t)
-> Trucks (19t to 44t)
-> Lastkraftwagen (19t bis 44t)



Autres options et versions disponibles sur demande :

- Bleu véhicules prioritaires et d'urgences
- Phares de travail avant, arrière, latéraux
- Rappel stop, position, indicateur de direction
- Traffic master
- Interface véhicule mécanique et électronique

Other options and versions available on request:

- Blue priority and emergency vehicles
- Work lights and alley lights
- Additional stop, position, direction indicator
- Traffic master
- Mechanical and electronic vehicle interface

Weitere Optionen und Versionen auf Anfrage:

- Blaue Einsatz- und Notfallfahrzeuge
- Arbeitsscheinwerfer und Gassenlichter
- Zusätzlicher Bremslicht, Positionslicht, Richtungsanzeiger
- Verkehrsleitsystem
- Mechanische und elektronische vehicle Schnittstelle

MULTILED



LED

10/30V
18 W

✓ R65 ✓ R10

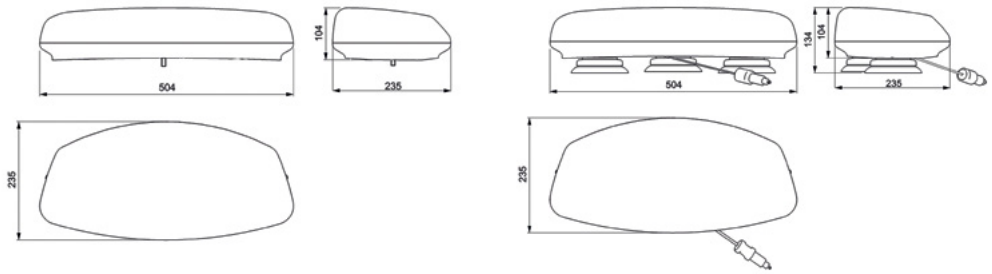

3 Types de flash homologués ECE R65
3 Flash patterns certified ECE R65
3 Blitzarten ECE R65 zugelassen



D14504
(23.51.L05.5V8)



D14505
(23.51.LM5.5V8)



D14506
(23.51.811.VLG)

cabochon - lens - Lichtscheibe



MULTILUX



H1

12/24V

✓ R65 ✓ R10



lampes 12/24V fournies
- 12/24V bulbs included -
inklusive Glühlampen 12/24V

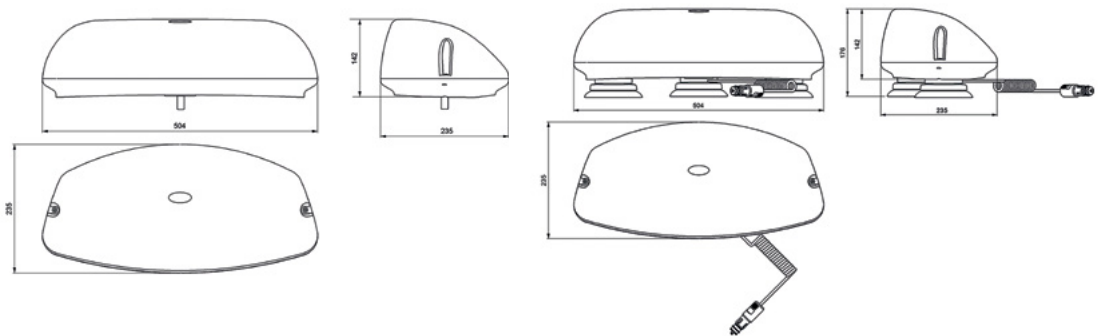

D14472
(2350.03T.PVL)



D14473
(2350.M3T.PVL)



D14474
(2350.811.VLG)

cabochon - lens - Lichtscheibe



Triflash



LED à éclats
LED Flash
Blitze LED



Polycarbonate
Polycarbonate
Polycarbonat



Pièces détachées
Spare parts
Ersatzteile



Flashez le QR code pour plus d'infos
Scan the QR code for more info
Scannen Sie den QR-Code für weitere Informationen



Indice de protection IP - solides/liquides
IP ingress protection - solids/liquids
IP Schutzfaktor - Fremdkörper/Wasser



Homologation circulation réseau routier public
Approval circulation on public road network
Genehmigung des öffentlichen Straßennetzes



Homologation CEM - compatibilité électromagnétique
EMC approval - Electromagnetic Compatibility
EMV zulassung - Elektromagnetische Verträglichkeit

TRIFLASH 500



LED

10/30V
9,5 W

R10

PC/ABS

IP6K9K

< 3,5t



* kit de relevage manuel inclus - manual lift kit included - manueller Aufzug inklusive

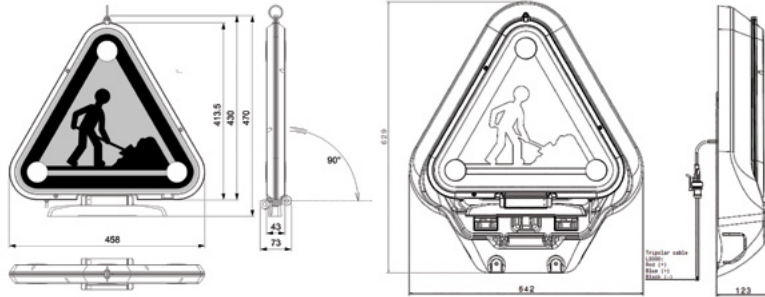

Symbole AK5 - Compact - Léger (3,15 Kg) - Homologué
AK5 symbol - Compact - Light (3,15 Kg) - Approved
AK5-Symbol - Kompakt - Leicht (3,15 kg) - Zugelassen



D14760 *
(2090L51200)



Classe 1 : ville et route nationale - town and trunk roads - Stadt und Landstrassen



D14762 *
(2090L52200)



Classe 2 : autoroutes et voies rapides - highways - Autobahnen und Schnellstrassen

NEW

ELEC



D14925
(2090L5220E)



Classe 2 : autoroutes et voies rapides - highways - Autobahnen und Schnellstrassen

TRIFLASH 700



LED

10/30V
9,5 W

R10

PC/ABS

IP6K9K

> 3,5t



* kit de relevage manuel inclus - manual lift kit included - manueller Aufzug inklusive

NEW



D14926 *
(2090L72200)



Classe 2 : autoroutes et voies rapides - highways - Autobahnen und Schnellstrassen

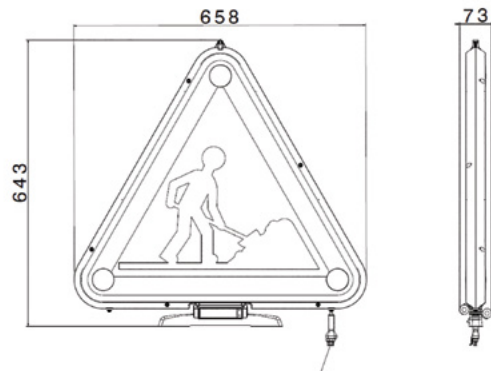

TRIFLASH ACC



LED

10/30V
9,5 W

R65 **R10**



IP6K9K

Exemple de montage D14762 + D14930
Assembly suggestion D14762 + D14930
Montagebeispiel D14762 + D14930



110 cm



D14932
(2090L1B110)

Pour Triflash avec 1 gyrophare LED
For Triflash with 1 LED beacon
Für Triflash mit 1 LED rundumkennleuchte

136 cm



D14933
(2090L1B136)

Pour Triflash avec 1 gyrophare LED
For Triflash with 1 LED beacon
Für Triflash mit 1 LED rundumkennleuchte

155 cm



D14934
(2090L1B151)

Pour Triflash avec 1 gyrophare LED
For Triflash with 1 LED beacon
Für Triflash mit 1 LED rundumkennleuchte

110 cm



D14929
(2090L2B110)

Pour Triflash avec 2 gyrophares LED
For Triflash with 2 LED beacons
Für Triflash mit 2 LED rundumkennleuchten

136 cm



D14930
(2090L2B136)

Pour Triflash avec 2 gyrophares LED
For Triflash with 2 LED beacons
Für Triflash mit 2 LED rundumkennleuchten

155 cm



D14931
(2090L2B151)

Pour Triflash avec 2 gyrophares LED
For Triflash with 2 LED beacons
Für Triflash mit 2 LED rundumkennleuchten

181 cm



D14935
(2090L2B181)

Pour Triflash avec 2 gyrophares LED
For Triflash with 2 LED beacons
Für Triflash mit 2 LED rundumkennleuchten



D14928
(2090805000)

Kit de relevage manuel pour -
manual lift kit for - manuelier
Aufzug für
D14760 - D14762 - D14926



D14922
(209080U000)

Support universel - Pattes de
fixation pour barre Triflash.
Universal bracket - Mounting
brackets for Triflash bar
Universalhalterung - für
Triflash- Dachträger



D14989
(2090804000)

Kit de fixation sur barre pour
Triflash électrique D14925.
Bar mounting kit for electric
Triflash D14925.
Stangenmontage-Kit für elek-
trischen Triflash D14925.

Feux de pénétration

Directional lights

Warnleuchten

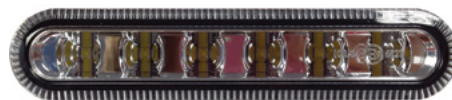
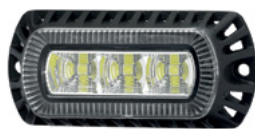

Flashez le QR code pour plus d'infos
Scan the QR code for more info
Scannen Sie den QR-Code für weitere Informationen



Indice de protection IP - solides/liquides
IP ingress protection - solids/liquids
IP Schutzfaktor - Fremdkörper/Wasser



Pièces détachées
Spare parts
Ersatzteile



Homologation circulation réseau routier public
Approval circulation on public road network
Genehmigung des öffentlichen Straßennetzes



Homologation CEM - compatibilité électromagnétique
EMC approval - Electromagnetic Compatibility
EMV zulassung - Elektromagnetische Verträglichkeit



Polycarbonate
Polycarbonate
Polycarbonat

Feux de pénétration - Directional lights - Warnleuchten

DL SMALL



LED

10/30V
9 W

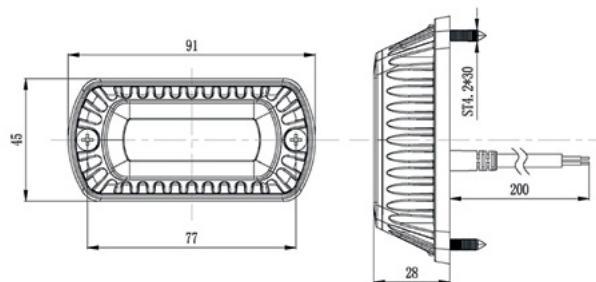
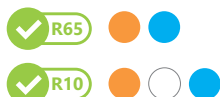

- D13860** ●
- D13863** ○
- D13862** ●

10 types de flash
10 flash patterns
10 Blitzmuster

Single (440ms)	Single (1000ms)
Double (480ms)	Triple (930ms)
Quad (725ms)	Penta (850ms)
Double (1000ms)	Triple (750ms)
Quad (610ms)	Penta (800ms)

DL LONG



LED

10/30V
12 W

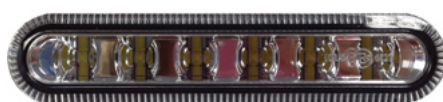
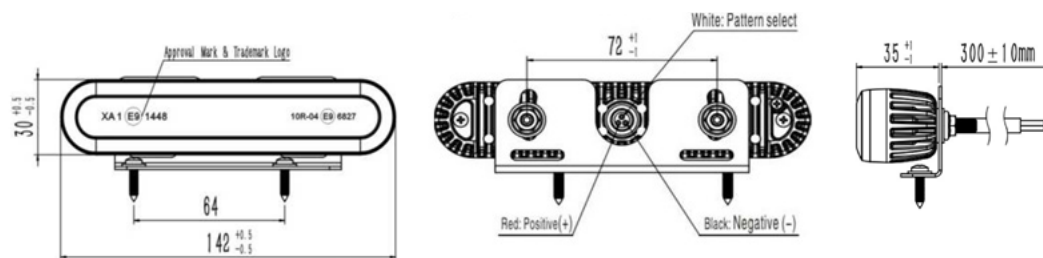
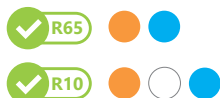

- D14190** ●
- D14354** ○
- D14353** ●

10 types de flash
10 flash patterns
10 Blitzmuster

One Flash (600ms)	In turn Double Flash (800ms)
In turn 4 Flash (800ms)	3 Flash (600ms)
5 Flash (1000ms)	1 Flash (960ms)
In turn 3 Flash (600ms)	Unique (410ms)
Frequent Flash (60ms)	Combination



Alternative flash ← →

Alarmes sonores de recul

Back-up alarms

Rückfahrwarner



Standard



Multi-Frequency



Flashez le QR code pour plus d'infos
Scan the QR code for more info
Scannen Sie den QR-Code für weitere Informationen



Indice de protection IP - solides/liquides
IP ingress protection - solids/liquids
IP Schutzfaktor - Fremdkörper/Wasser



Pièces détachées
Spare parts
Ersatzteile



Homologation CEM - compatibilité électromagnétique
EMC approval - Electromagnetic Compatibility
EMV zulassung - Elektromagnetische Verträglichkeit

Alarmes sonores de recul - Back-up alarms - Rückfahrwarner

ASR



STANDARD - HERKÖMLICH

101 mm x 67 mm x 41 mm

Standard



1. Chariots élévateurs, petits camions, VUL
Forklifts, small trucks, LCV
Gabelstapler, Lieferwagen, Transporter
2. Toute utilisation. Ajustement automatique 10 db supérieur au bruit ambiant
All use. Automatic adjustment 10dB higher than the environment noise
Alle Anwendungsbereiche. Automatische Lautstärkeanpassung +10db über Umgebungslärm
3. Benne à ordure, chantier, forêt, PL
Waste collection vehicles, forest work vehicles, trucks
Müllfahrzeuge, Baustellenfahrzeuge, Forstfahrzeuge, LKW



12/24V



IP65

1	630120	87 db
2	630110	82-102 db
3	630100	102 db

MULTI-FRÉQUENCE - MULTI-FREQUENCY - MEHRFACHFREQUENZ

102 mm x 71 mm x 41 mm

Multi-Frequency



D13807	87 db
D13808	97 db

Multi-Frequency



D13810	97 db 1500 mm
---------------	------------------

CLICK-IN



24V

INTÉGRÉE - BUILT-IN - EINGEBAUT



001830	90 db
---------------	-------

Pour connection sur feu arrière LC8 p. 150
To plug in LC8 rear lamp p. 150
Zum direkten Anschluss an die Heckleuchte LC8 S. p. 150



001872	55-90db
---------------	---------

Ajustement bruit ambiant sur feu arrière LC8 MAN p. 153
Environment noise adjustment MAN LC8 rear lamp p. 153
Automatische Umgebungslärm Heckleuchte MAN LC8 S. p. 153



D12953	90 db
---------------	-------

Pour connection sur feu arrière LC9 p. 160, LC7 p. 166
To plug in LC9 / LC7 rear lamp p. 160 / p. 166
Zum direkten Anschluss an die Heckleuchte LC9 S. p. 160, LC7 S. p. 166

Systèmes caméra

Camera systems

Kamera-Systeme

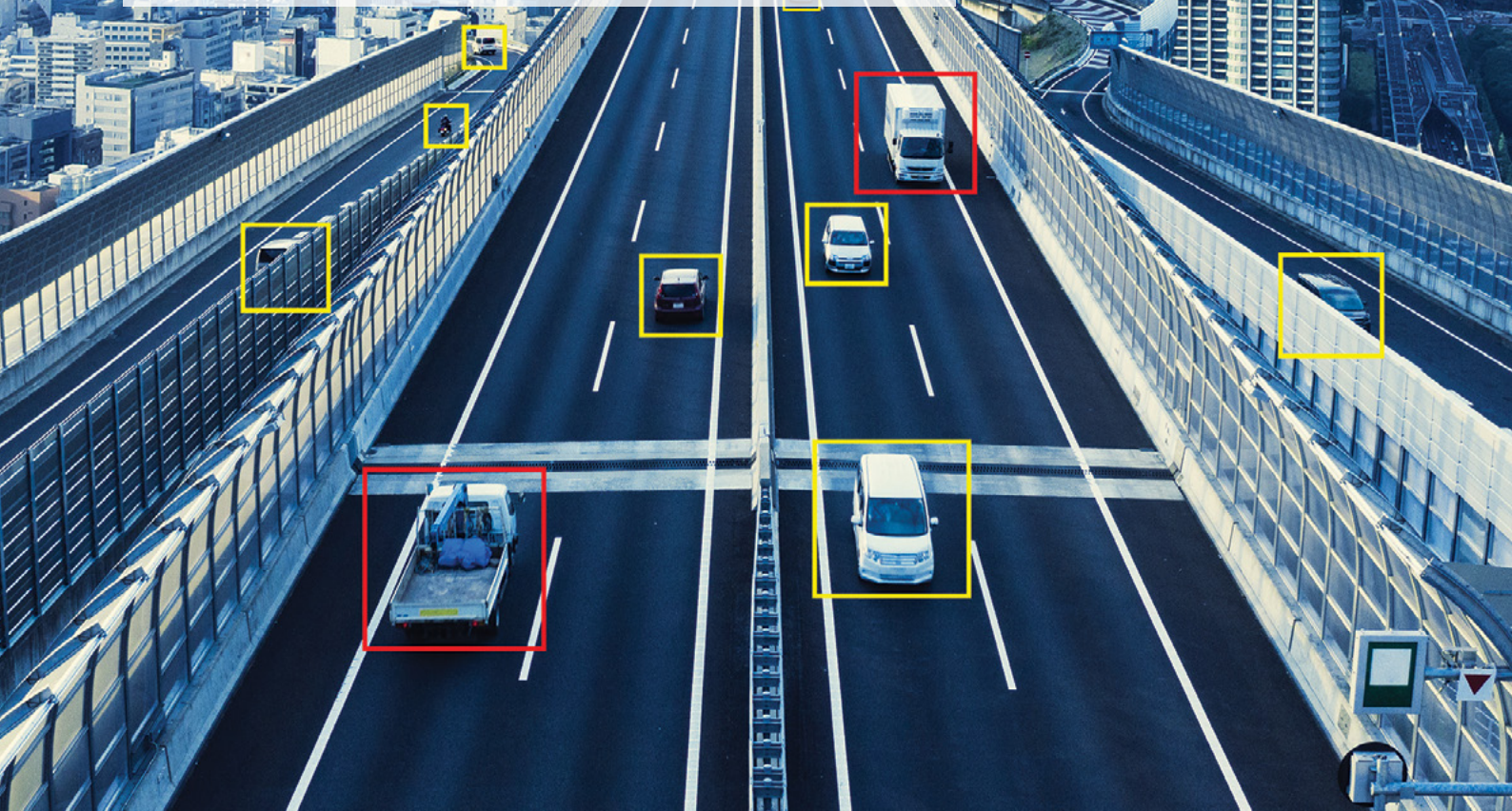

Systèmes sans fil - Wireless Systems - Drahtlose systeme

p. 276-280



Systèmes filaires - Wired systems - Verdrahtete systeme

p. 281-290



Flashez le QR code pour plus d'infos
Scan the QR code for more info
Scannen Sie den QR-Code für weitere Informationen



Système HD
HD system
HD systeme



Indice de protection IP - solides/liquides
IP ingress protection - solids/liquids
IP Schutzfaktor - Fremdkörper/Wasser



Écran tactile
Touch screen
Berührungsbildschirm



Pièces détachées
Spare parts
Ersatzteile



Caméra vision nocturne
Night vision camera
Nächtsichtkamera



Taille écran
Screen size
Bildschirmgröße



Écran fractionné
Split screen
geteilter Bildschirm



Système sans fil
Wireless system
Drahtlose systeme

CAM WIRELESS 2.4 GHz



D14328

12/24V - Ecran fractionné couleur 7 pouces - transmission sans fil 2.4 GHz - Raccordement jusqu'à 4 caméras - **appairage automatique** - Enregistrement en temps réel - Support carte micro SD (non fournie) - Caméra micro intégré - vision de nuit - Utilisation entre -20°C et +70°C

12/24V - 7 inch colour quad screen - Wireless transmission 2.4 GHz - connecting up to 4 wireless cameras - **Auto scan** - Real time recording - Support SD card - Camera with micro integrated - night vision - Use between -20°C and +70°C

12/24V - 7" Farbbildschirm - Übertragungsfrequenz 2,4 GHz - bis zu 4 drahtlose Kameras anschließbar - **Automatischer Abgleich** - Echtzeitaufnahme - SD Karten Aufnahme - Nachtsichtkamera mit integriertem Mikrofon - Betriebstemperatur -20°C bis +70°C



TEMPS D'ENREGISTREMENT - RECORDING TIME - AUFNAHMEZEIT :

MODE \ Micro SD	8G	16G	32G	64G	128G
SINGLE (640x480x1)	14h	28h	55h	110h	220h
QUAD (320x240x4)	11h	22h	43h	86h	172h
SPLIT (400x480x2)	13h	25h	50h	101h	201h

NOTICE DE BRANCHEMENT - CONNECTION INSTRUCTIONS - ANSCHLUSSANWEISUNGEN :



rouge positif - red positive - rot positiv
 noir masse - black ground - schwarz Erdung
 marron recul - brown reverse - Braun Zurückfahren
 blanc clignotant gauche - white left indicator - Weiß Blinker links
 bleu clignotant droit - blue right indicator - Blau Blinker rechts
 vert ou jaune option - green or yellow trigger option - grüne oder gelbe Triggeroption



Les appareils 2.4 GHz tels que les téléphones cellulaires, les systèmes Bluetooth et Wi-Fi peuvent causer des interférences passagères. 2.4 GHz devices such as mobile phones, Bluetooth and Wi-Fi may cause some temporary interferences. Bei gleichzeitigem Betrieb von Geräten, die im Frequenzbereich von 2,4 GHz arbeiten, wie z.B. Mobiltelefone, Bluetooth und WLAN Übertragungen, können gelegentlich Störinterferenzen auftreten.



COMPOSEZ VOTRE KIT SUR-MESURE
 BUILD YOUR OWN CUSTOM KIT
 STELLEN SIE SICH IHR KIT MASSGESCHNEIDERT ZUSAMMEN

1. ECRAN - MONITOR - FARBBILDSCHIRM



D14216

Ecran 7" - 7" screen - 7" Farbbildschirm
 Fractionnable - Multi display - Teilbar

2. CAMÉRA - CAMERA - KAMERA



D14236

NEW



D14906

NEW



D14882

batterie rechargeable
 rechargeable battery
 Akku

3. ACCESSOIRES - ACCESSORIES - ZUBEHÖR



D14063

7 m



D14326

antenne écran - screen antenna
 - Bildschirmantenne



D14195

antenne caméra - camera
 antenna - Kameraantenne



D14347

10/32V

Batterie mobile - 10-12h autonomie
 Mobile battery - 10-12h autonomy
 Mobilbatterie - 10-12h autonomie



Exemple de montage - Assembly suggestion - Montage-
 beispiel
 Kit D14328 + D14236 x 3

CAM WIRELESS HD 2.4 GHz



NEW



D14805

12/24V - Image HD 720P - Ecran fractionné couleur 7 pouces - transmission sans fil 2.4 GHz - Raccordement jusqu'à 4 caméras - **appairage automatique** - Enregistrement en temps réel - Support carte micro SD (non fournie) - Caméra micro intégré - vision de nuit - Utilisation entre -20°C et +70°C

12/24V - HD 720P image - 7 inch colour quad screen - Wireless transmission 2.4 GHz - connecting up to 4 wireless cameras - **Auto scan** - **Real time recording** - **Support SD card** - Camera with micro integrated - night vision - Use between -20°C and +70°C

12/24V - HD 720P-Bild - 7" Farbbildschirm - Übertragungsfrequenz 2,4 GHz - bis zu 4 drahtlose Kameras anschließbar - **Automatischer Abgleich** - **Echtzeitaufnahme** - **SD Karten Aufnahme** - Nachtsichtkamera mit integriertem Mikrofon - Betriebstemperatur -20°C bis +70°C



TEMPS D'ENREGISTREMENT - RECORDING TIME - AUFNAHMEZEIT :

MODE \ Micro SD	8G	16G	32G	64G	128G
SINGLE (640x480x1)	14h	28h	55h	110h	220h
QUAD (320x240x4)	11h	22h	43h	86h	172h
SPLIT (400x480x2)	13h	25h	50h	101h	201h

NOTICE DE BRANCHEMENT - CONNECTION INSTRUCTIONS - ANSCHLUSSANWEISUNGEN :



rouge positif - red positive - rot positiv
 noir masse - black ground - schwarz Erdung
 marron recul - brown reverse - Braun Zurückfahren
 blanc clignotant gauche - white left indicator - Weiß Blinker links
 bleu clignotant droit - blue right indicator - Blau Blinker rechts
 vert ou jaune option - green or yellow trigger option - grüne oder gelbe Triggeroption



Les appareils 2.4 GHz tels que les téléphones cellulaires, les systèmes Bluetooth et Wi-Fi peuvent causer des interférences passagères. 2.4 GHz devices such as mobile phones, Bluetooth and Wi-Fi may cause some temporary interferences. Bei gleichzeitigem Betrieb von Geräten, die im Frequenzbereich von 2,4 GHz arbeiten, wie z.B. Mobiltelefone, Bluetooth und WLAN Übertragungen, können gelegentlich Störinterferenzen auftreten.

ACC WIRELESS HD 720P



COMPOSEZ VOTRE KIT SUR-MESURE
 BUILD YOUR OWN CUSTOM KIT
 STELLEN SIE SICH IHR KIT MASSGESCHNEIDERT ZUSAMMEN

1. ECRAN - MONITOR - FARBBILDSCHIRM

NEW



D14803

Ecran 7" - 7" screen - 7" Farbbildschirm
 Fractionnable - Multi display - Teilbar

2. CAMÉRA - CAMERA - KAMERA

NEW

∠110°



D14804

NEW

∠110°



D14905

capot motorisé - auto-shutter -
 motorisierter Decke



3. ACCESSOIRES - ACCESSORIES - ZUBEHÖR



D14326

antenne écran - screen antenna
 - Bildschirmantenne



D14195

antenne caméra - camera
 antenna - Kameraantenne



D14347

10/32V

Batterie mobile - 10-12h autonomie
 Mobile battery - 10-12h autonomy
 Mobilbatterie - 10-12h autonomie

CAM WIFI



∠110°

NEW



D14806



Magnétique et sur batterie rechargeable, l'installation est rapide et simple. Après avoir téléchargé l'application sur votre **smartphone** ou tablette (voir notice), vous pouvez regarder en temps réel la vidéo par wifi mais aussi faire des captures d'écran. Câble de rechargement USB fourni.



Magnétique et sur batterie rechargeable, l'installation est rapide et simple. Après avoir téléchargé l'application sur votre **smartphone** ou tablette (voir notice), vous pouvez regarder en temps réel la vidéo par wifi mais aussi faire des captures d'écran. Câble de rechargement USB fourni.

Magnetisch und auf wiederaufladbarer Batterie, die Installation ist schnell und einfach. Nach dem Herunterladen der App auf Ihr **Smartphone** oder Tablet (siehe Anleitung) können Sie sich das Video in Echtzeit über Wifi ansehen, aber auch Screenshots machen. USB-Ladekabel enthalten.



RECOMMANDÉ IOS + ANDROID
RECOMMENDED IOS + ANDROID
EMPFOHLEN IOS + ANDROID



CAM WIRED



ENVIRONNEMENT SEVERE
HARSH ENVIRONMENT
EXTREME UMWELTBEDINGUNGEN

∠120°



20 m

NEW

D14091

12/24V - Ecran couleur 7 pouces - Raccordement possible pour 1 caméra - Caméra LED en aluminium/inox micro intégré - vision de nuit - Utilisation entre -40°C et +70°C

12/24V - 7 inch colour screen - Connection possible for 1 camera - LED aluminium/stainless steel camera with micro integrated - night vision - Use between -40°C and +70°C

12/24V - 7" Farbbildschirm - bis zu 1 Kamera anschließbar - LED - Nachtsichtkamera aus Aluminium/Edelstahl mit integriertem Mikrofon - Betriebstemperatur -40°C bis +70°C



CAM WIRED

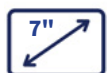

∠ 120°



20 m

NEW

D14915

12/24V - Ecran couleur 7 pouces - Raccordement possible pour 1 caméra - Caméra LED CMOS micro intégré - vision de nuit - Utilisation entre -40°C et +70°C

12/24V - 7 inch colour screen - Connection possible for 1 camera - LED CMOS camera with micro integrated - night vision - Use between -40°C and +70°C

12/24V - 7" Farbbildschirm - bis zu 1 Kamera anschließbar - LED - Nachtsichtkamera CMOS mit integriertem Mikrofon - Betriebstemperatur -40°C bis +70°C



CAM WIRED

NOTICE DE BRANCHEMENT D14091 - D14915 - CONNECTION INSTRUCTIONS - ANSCHLUSSANWEISUNGEN :



rouge positif - red positive - rot positiv
 noir masse - black ground - schwarz Erdung
 Fil marron recul - brown wire reverse - Braun-Draht Zurückfahren
 connecteur marron caméra - brown connector camera - Braun-anschluss Kamera

ACC WIRED



COMPOSEZ VOTRE KIT SUR-MESURE

BUILD YOUR OWN CUSTOM KIT

STELLEN SIE SICH IHR KIT MASSGESCHNEIDERT ZUSAMMEN



12/24V

1. ECRAN - MONITOR - FARBBILDSCHIRM

NEW



D14916

Ecran 7" - 7" screen - 7" Farbbildschirm
 Pour 1 caméra - For 1 camera - Für 1 Kamera



2. CAMÉRA - CAMERA - KAMERA



12/24V

∠120°



D13617

∠120°



D13881

Aluminium/Inox - Aluminum / Stainless steel - Aluminium / Edelstahl

∠150°



D14148

Slim grand angle
 Slim wide angle
 Slim 150° winkel

∠120°



D14327

Motorisée + chauffante
 Motorized + auto heater
 Motorisierte + Heizung

ACC WIRED



2. CAMÉRA - CAMERA - KAMERA

∠150°

NEW



D14808

Top view grand angle
Top view wide angle
Top view 150° winkel



∠150°

NEW



D14807

Top view grand angle
Top view wide angle
Top view 150° winkel

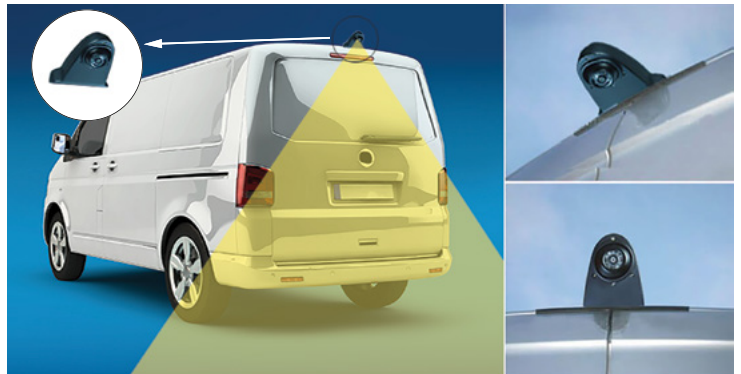

3. CÂBLAGE - WIRING - VERKABELUNG



D13620



D13621 10 m

D13622 20 m



EXEMPLES DE MONTAGE - ASSEMBLY SUGGESTION - MONTAGEBEISPIEL



CAM WIRED HD 720P



ENVIRONNEMENT SEVERE
HARSH ENVIRONMENT
EXTREME UMWELTBEDINGUNGEN



∠110°



20 m

NEW

D14904



12/24V - Qualité d'image HD 720P - Ecran couleur 7 pouces - Raccordement jusqu'à 3 caméras - Caméra LED en inox micro intégré - vision de nuit - Utilisation entre -20°C et +70°C

12/24V - 720P HD image quality - 7 inch colour screen - Connecting up to 3 cameras - LED stainless steel camera with micro integrated - night vision - Use between -20°C and +70°C

12/24V - 720P HD-Bildqualität - 7" Farbbildschirm - bis zu 3 Kameras anschließbar - LED - Nachtsichtkamera aus Edelstahl mit integriertem Mikrofon - Betriebstemperatur -20°C bis +70°C

CAM WIRED HD 720P



∠110°



20 m

NEW

D14903



12/24V - Qualité d'image HD 720P - Ecran couleur 7 pouces - Raccordement jusqu'à 3 caméras - Caméra LED en aluminium micro intégré - vision de nuit - Utilisation entre -20°C et +70°C

12/24V - 720P HD image quality - 7 inch colour screen - Connecting up to 3 cameras - LED aluminum camera with micro integrated - night vision - Use between -20°C and +70°C

12/24V - 720P HD-Bildqualität - 7" Farbbildschirm - bis zu 3 Kameras anschließbar - LED - Nachtsichtkamera aus Aluminium mit integriertem Mikrofon - Betriebstemperatur -20°C bis +70°C

CAM WIRED HD 720P

NOTICE DE BRANCHEMENT D14904 - D14903 - CONNECTION INSTRUCTIONS - ANSCHLUSSANWEISUNGEN :



ACC WIRED HD 720P



COMPOSEZ VOTRE KIT SUR-MESURE

BUILD YOUR OWN CUSTOM KIT

STELLEN SIE SICH IHR KIT MASSGESCHNEIDERT ZUSAMMEN



12/24V

1. ECRAN - MONITOR - FARBBILDSCHIRM

2. CAMÉRA - CAMERA - KAMERA

NEW



D14901

Ecran 7" - 7" screen - 7" Farbbildschirm
 Pour 3 caméras - For 3 cameras - Für 3 Kameras

∠110°



D14900

Aluminium - Aluminum - Alu-
 minium

∠110°



D14902

Inox - Stainless steel - Edelstahl



HD
720P

3. CÂBLAGE - WIRING - VERKABELUNG



D13620

Pour 1 caméra HD720P - For 1
 HD 720P camera - Für 1 HD720P
 Kamera



D14685

Pour 2 caméras HD - For 2 HD
 cameras - Für 2 HD Kameras



D13621

10 m

D13622

20 m

CAM WIRED HD 1080P



D14677

12/24V - Qualité d'image HD 1080P - Ecran couleur 7 pouces tactile - Raccordement jusqu'à 3 caméras - Design épuré

12/24V - 1080P HD image quality - 7 inch colour touch screen - Connecting up to 3 cameras - Sleek design

12/24V - 1080P HD-Bildqualität - 7" Berührungsempfindlicher Farbbildschirm - bis zu 3 Kameras anschließbar - Glatt Design



CAM WIRED HD 1080P



D14680

12/24V - Qualité d'image HD 1080P - Ecran couleur 10 pouces tactile - Raccordement jusqu'à 3 caméras - Design épuré

12/24V - 1080P HD image quality - 10 inch colour touch screen - Connecting up to 3 cameras - Sleek design

12/24V - 1080P HD-Bildqualität - 10" Berührungsempfindlicher Farbbildschirm - bis zu 3 Kameras anschließbar - Glatt Design



CAM WIRED HD 720P

NOTICE DE BRANCHEMENT D14677 - D14680 - CONNECTION INSTRUCTIONS - ANSCHLUSSANWEISUNGEN :



Exemple de montage - Assembly suggestion - Montagebeispiel
Kit D14677 + D13621 + D13685

ACC WIRED HD 1080P



COMPOSEZ VOTRE KIT SUR-MESURE

BUILD YOUR OWN CUSTOM KIT

STELLEN SIE SICH IHR KIT MASSGESCHNEIDERT ZUSAMMEN



12/24V

HD
1080P



1. ECRAN - MONITOR - FARBBILODSCHIRM



D14678

Ecran mono HD 7" - 7" mono HD screen - 7" Mono HD-Farbbildschirm



D14681

Ecran mono HD 10" - 10" mono HD screen - 10" Mono HD-Farbbildschirm



D14683

Ecran quad HD 7" fractionnable - 7" quad HD screen Multi display - 7" Quad HD-Farbbildschirm Teilbar



D14684

Ecran quad HD 10" fractionnable - 10" quad HD screen Multi display - 10" Quad HD-Farbbildschirm Teilbar

NOTICE DE BRANCHEMENT D14683 - D14684 - CONNECTION INSTRUCTIONS - ANSCHLUSSANWEISUNGEN :

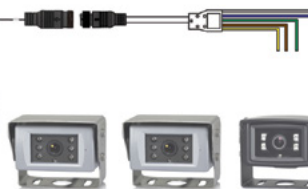

rouge positif - red positive - rot positiv
noir masse - black ground - schwarz Erdung
fil blanc positif Cam1 - white wire positive Cam1 - Weiß-Draht positiv Kam1
fil bleu positif Cam2 - blue wire positive Cam2 - Blau-Draht positiv Kam2
fil vert positif Cam3 - green wire positive Cam3 - Grün-Draht positiv Kam3
fil marron positif Cam4 - brown wire positive Cam4 - Braun-Draht positiv Kam4
fil jaune activation écran fractionné - yellow wire split trigger - Aktivierung des Split-Bildschirms mit gelbem Draht
connecteur blanc Cam1 - white connector Cam1 - Weiß-anschluss Kam1
connecteur bleu Cam2 - blue connector Cam2 - Blau-anschluss Kam2
connecteur vert Cam3 - green connector Cam3 - Grün-anschluss Kam3
connecteur marron Cam4 - brown connector Cam4 - Braun-anschluss Kam4

2. CAMÉRA - CAMERA - KAMERA

∠130°



D14679

Aluminium - Aluminum - Aluminium HD 1080P

∠130°



D14682

Inox - Stainless steel - Edelstahl HD 1080P

3. CÂBLAGE - WIRING - VERKABELUNG



D14685

Pour 2 caméras HD720P - For 2 HD 720P cameras - Für 2 HD720P Kameras



D13621

10 m

D13622

20 m



Exemple de montage - Assembly suggestion - Montagebeispiel

CAM 360° HD 1080P



∠190°



NEW

D14859

12/24V - Qualité d'image HD 1080P - 1 boîtier de contrôle + 4 caméras HD 1080P extra grand angle 190°. Écran non inclus.

12/24V - 1080P HD image quality - 1 control box + 4 HD 1080P 190° extra wide angle cameras. Monitor not included.

12/24V - 1080P HD-Bildqualität - 1 Steuerkasten + 4 HD 1080P Extraweitwinkel 190° Kameras. Bildschirm nicht enthalten.



D14678

Ecran mono HD 7" - 7" mono HD screen - 7" Mono HD-Farbbildschirm



D14681

Ecran mono HD 10" - 10" mono HD screen - 10" Mono HD-Farbbildschirm



D14683

Ecran quad HD 7" fractionnable - 7" quad HD screen Multi display - 7" Quad HD-Farbbildschirm Teilbar



D14684

Ecran quad HD 10" fractionnable - 10" quad HD screen Multi display - 10" Quad HD-Farbbildschirm Teilbar

NEW



D14901

Ecran 7" - 7" screen - 7" Farbbildschirm
Pour 3 caméras - For 3 cameras - Für 3 Kameras



CAM WIRED DETECTION



NEW $\angle 140^\circ$

ALERTE AUDIO
AUDIO ALERT
AUDIO-ALARM

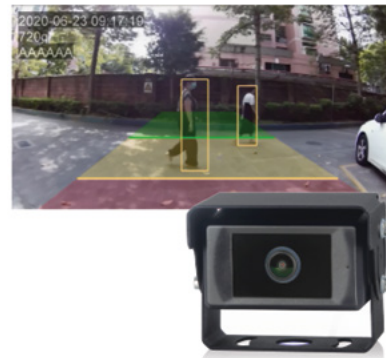

12/24V



IP69K



D14995

12/24V - Qualité d'image HD 1080P - Détection de piétons et cyclistes 0,5 - 12 m

12/24V - 1080P HD image quality - Pedestrian and cyclist detection 0,5 - 12 m

12/24V - 1080P HD-Bildqualität - Fußgänger- und Radfahrerererkennung 0,5 - 12 m



D14678

Ecran mono HD 7" - 7" mono
HD screen - 7" Mono HD-Farb-
bildschirm



D14681

Ecran mono HD 10" - 10" mono
HD screen - 10" Mono HD-Farb-
bildschirm



D13621

10 m

D13622

20 m

CAM WIRED MIRRORS



NEW

NEW



12/24V



IP69K



D14955

Ecran miroir HD 12,3" - 12,3" mirror HD
screen - 12,3" Mono HD-Spiegelbildschirm



D14956

Coffres porte extincteur

Extinguisher boxes

Feuerlöscherbehälter



Flashez le QR code pour plus d'infos
Scan the QR code for more info
Scannen Sie den QR-Code für weitere Informationen

Coffres porte extincteur - Extinguisher boxes - Feuerlöscherbehälter

5054

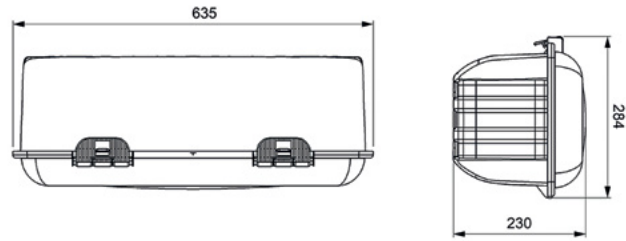

Max 6 kg

D14538
(50.52.925.TV2)

Avec sangle nylon - with nylon strap - mit nylon Riemen



Max 6 kg

D14539
(50.52.925.TVC)

Avec sangle CLIP réglable - with adjustable CLIP strap - mit verstellbaren Riemen CLIP

5051

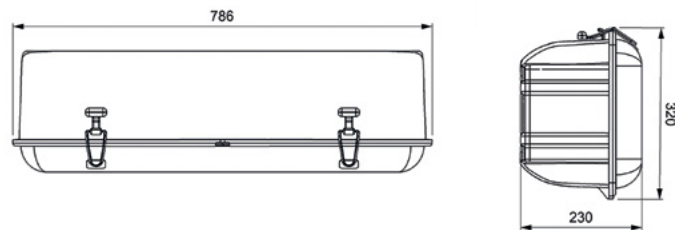

Max 9 kg

D14537
(50.51.020.VLG)

Avec sangle plastique - with plastic strap - mit Kunststoff Riemen

Prises et câbles spiralés

Plugs and coils

Stecker und Spiralkabel



NEW



NEW



Flashez le QR code pour plus d'infos
Scan the QR code for more info
Scannen Sie den QR-Code für weitere Informationen



24V

24N (ISO 1185)
24S (ISO 3731)

MÉTALLIQUE - METAL - METALL



D10873

24N

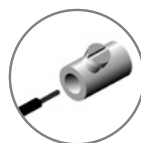

611530

24N



D10874

24S



611550

24S

PLASTIQUE - PLASTIC - KUNSTSTOFF



611500

24N

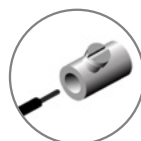

611580

24N



611510

24S



611590

24S



611520

24N



611540

24S

C7P



Longueur de travail : L
Working length : L
Arbeitslänge : L

LMax
Longueur d'extension maximale
Maximum extension length
Maximale Ausziehlänge

MÉTALLIQUE - METAL - METALL



24N

D14313 LMax 3,5 m

611140 L : 3 m, LMax 4,5 m



24S

D14314 LMax 3,5 m

611150 L : 3 m, LMax 4,5 m

PLASTIQUE - PLASTIC - KUNSTSTOFF



24N

D14312 LMax 3,5 m

611070 L : 3 m, LMax 4,5 m



24S

D14316 LMax 3,5 m

611080 L : 3 m, LMax 4,5 m

EURO6

D14574 L : 3 m, LMax 4,5 m

D14575 L : 3 m, LMax 4,5 m

EURO6

6 x 1,0 mm² + 1 x 1,5 mm²



611110 24N/24S

24N

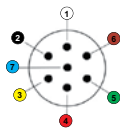

- ① - Masse
- ② - Feu de position G
- ③ - Clignotant G
- ④ - Feu Stop
- ⑤ - Clignotant D
- ⑥ - Feu de position D,
- ⑦ - Commande de frein

- Common return
- L rear position lamp
- L flasher lamp
- Stop lamp
- R flasher lamp
- R rear position lamp,
- Breaking control

- Masse
- Linke Schlussleuchte
- Fahrrichtungsanzeiger links
- Bremsleuchte
- Fahrrichtungsanzeiger rechts
- Rechte Schlussleuchte
- Steuerung Anhängerbremse

24S

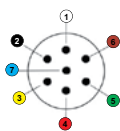

- ① - Masse
- ② - Sans affectation
- ③ - Feu de recul
- ④ - Alimentation en puissance
- ⑤ - Sans affectation
- ⑥ - Sans affectation
- ⑦ - Feu AR de brouillard

- Common return
- Without affectation
- Reverse lamp
- Power supply
- Without affectation
- Without affectation
- Fog lamp

- Masse
- Nicht belegt
- Rückfahrleuchte
- Stromversorgung (Dauerplus)
- Nicht belegt
- Nicht belegt
- Nebelschlussleuchte

15P



24V

ISO 12098



A10060



A10061



D14315 LMax 3,5 m

D11578 L : 3 m, LMax 4,5 m

D14577 L : 3 m, LMax 4,5 m **EURO6**

7P-15P



24V



D11487 L : 3 m, LMax 4,5 m

NEW D14824 LMax 3,5 m



D14689 L : 3 m, LMax 4,5 m

EURO6 D14578 L : 3 m, LMax 4,5 m

NEW D14802 LMax 3,5 m



611410



D13889



A10064

ABS/EBS



ISO 7638-1



611560 ABS/EBS



A10062 ABS/EBS



A10065 ABS/EBS

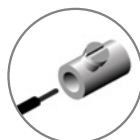

A10066 ABS/EBS



D14311 LMax 3,5 m ABS/EBS 7P

D10597 L : 3 m, LMax 4,5 m ABS/EBS 7P

D14576 L : 3 m, LMax 4,5 m ABS/EBS 7P **EURO6**



611570 PARC ABS/EBS-15P

ABS/EBS



- | | | |
|---|--------------------|--------------------|
| ① - Plus (+) alimentation électrovanne | Plus electrovalve | Plus Magnetventil |
| ② - Plus (+) connexions électroniques | Plus electronics | Plus Elektronik |
| ③ - Moins (-) connexions électroniques | Minus electronics | Minus Elektronik |
| ④ - Moins (-) alimentation électrovanne | Minus electrovalve | Minus Magnetventil |
| ⑤ - Connexion lampe témoin | Warning device | Warnrichtung |
| ⑥ - Connexion donnée CANH | CANH | Datenleitung CANH |
| ⑦ - Connexion donnée CANL | CANL | Datenleitung CANL |

15 PÔLES

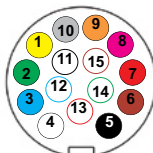

- | | | |
|--------------------------------------|----------------------------|---|
| ① - Clignotant gauche | L flasher lamp | Fahrtrichtungsanzeiger links |
| ② - Clignotant droit | R flasher lamp | Fahrtrichtungsanzeiger rechts |
| ③ - Feu AR de brouillard | Fog lamp | Nebelschlussleuchte |
| ④ - Masse | Common return | Masse |
| ⑤ - Feu de position gauche | L rear position lamp | Linke Schlussleuchte |
| ⑥ - Feu de position droit | R rear position lamp | Rechte Schlussleuchte |
| ⑦ - Feu stop | Stop lamp | Bremsleuchte |
| ⑧ - Feu de recul | Reverse lamp | Rückfahrleuchte |
| ⑨ - Alimentation 24V | 24V power supply | Stromversorgung +24V |
| ⑩ - Capteur d'usure des freins | Worn brake indicator | Sensor für Bremsbelagverschleissanzeige |
| ⑪ - Capteurs de pressions des freins | Brake pressure collector | Anzeige für Federspeicherbremse |
| ⑫ - Dispositif de levage d'essieu | Adjustable suspension lift | Achsanhebung |
| ⑬ - Masse pour contacts 14 et 15 | Common return | Masse für Datenleitungen |
| ⑭ - Bus de données | Data line | Datenleitung |
| ⑮ - Bus de données | Data line | Datenleitung |

9P ISOBUS IBBC



12V

ISO 11783-2

NEW



D14942



D14943

4P-IBBC



D14944

TBC



D14945 6 mm²

D14947 10 mm²

D14948 16 mm²



D14949 6 mm² - cable 5 m

D14950 10 mm² - cable 5 m

D14951 10 mm² - cable 10 m



Connecteurs Connectors Anschlussstecker



Flashez le QR code pour plus d'infos
Scan the QR code for more info
Scannen Sie den QR-Code für weitere Informationen

AMP 1.5-7P-M

Type connecteur - Nb pins - Mâle ou Femelle
Connector type - Pins Nb - Male or Female
Steckertyp - Stifte Nb - männlich oder weiblich

Connecteurs - Connectors - Anschlussstecker

AMP 1.5



D11868 AMP 1.5-7P-F

Connecteur AMP 1.5 simple
Single AMP 1.5 connector
Anschlussstecker AMP 1.5

Pour / For / Für
LC5, LC7, LC8, LC9, LC12, LC11, LC10



HDSCS



D13878 HDSCS-8P-F

Connecteur HDSCS simple
Single HDSCS connector
Anschlussstecker HDSCS

Pour / For / Für
LC8, LC11



JPT



D13876 JPT-2P-F

Connecteur JPT 2 voies
2 poles JPT connector
Anschlussstecker 2 polig JPT

Pour / For / Für
EPP98, SMD98,
FPL93, FE98



D13877 JPT-3P-F

Connecteur JPT 3 voies
3 poles JPT connector
Anschlussstecker 3 polig JPT

Pour / For / Für
ICDL94



POS



D13879 POS-2P-F

Connecteur 2 voies position femelle
2 pin female connector
Weiblich Anschlussstecker 2 polig

Pour / For / Für
LC8T, DX



D14214 POS-2P-M

Connecteur 2 voies position mâle
2 poles male connector
Männlich Anschlussstecker 2 polig

SUPERSEAL



D13880

SS-2P-F

Connecteur SUPERSEAL 2 voies femelle
2 poles female SUPERSEAL connector
Weiblich Anschlussstecker 2 polig

Pour / For / Für
SMD98, FPL93, LC12, IC DL10,
LPL18



D14208

SS-2P-M

Connecteur SUPERSEAL 2 voies mâle
2 poles male SUPERSEAL connector
Männlich Anschlussstecker 2 polig



D14362

SS-3P-F

Connecteur SUPERSEAL 3 voies femelle
3 poles female SUPERSEAL connector
Weiblich Anschlussstecker 3 polig

Pour / For / Für
SMCU



D14331

SS-3P-M

Connecteur SUPERSEAL 3 voies mâle
3 poles male SUPERSEAL connector
Männlich Anschlussstecker 3 polig

DT



D14170

DT-2P-F

connecteur 2 voies DT
2 poles DT connector
Anschlussstecker 3 polig DT

Pour / For / Für
feux de travail, work lights,
Arbeitsscheinwerfer

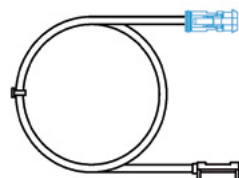

R12486

1500 mm

câble adaptateur DT 2V-CLICK-IN
adapter cable DT 2V-CLICK-IN
Adapterkabel DT 2V-CLICK-IN

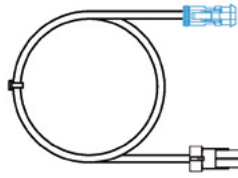

R14413

1500 mm

câble adaptateur DT-SUPERSEAL
adapter cable DT-SUPERSEAL
Adapterkabel DT-SUPERSEAL



D14436 DT06-4S-4P-F
connecteur 4 voies DT06-4S femelle
4 poles DT06-4S femaleconnector
Weiblich Ansschlussstecker 4 polig DT06-4S



Pour / For / Für
CTL15, BL15



D14434 DT04-4P-M
connecteur 4 voies DT04-4P mâle
4 poles DT04-4P male connector
Männlich Ansschlussstecker 4 polig DT04-4P



D14437 DTM06-4S-4P-F
connecteur 4 voies DTM06-4S femelle
4 poles DTM06-4S femaleconnector
Weiblich Ansschlussstecker 4 polig DTM06-4S

Pour / For / Für
CTL15, BL15



D14435 DTM04-4P-M
connecteur 4 voies DTM04-4P mâle
4 poles DTM04-4P male connector
Männlich Ansschlussstecker 4 polig DTM04-4P



D14352 DT-6P-M
connecteur 6 voies DT
6 poles DT connector
Ansschlussstecker 6 polig DT

Pour / For / Für
CHL



Faisceaux Harnesses Kabelsatz

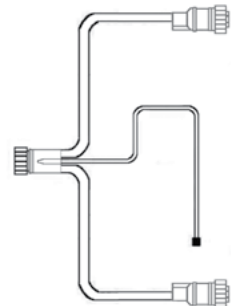
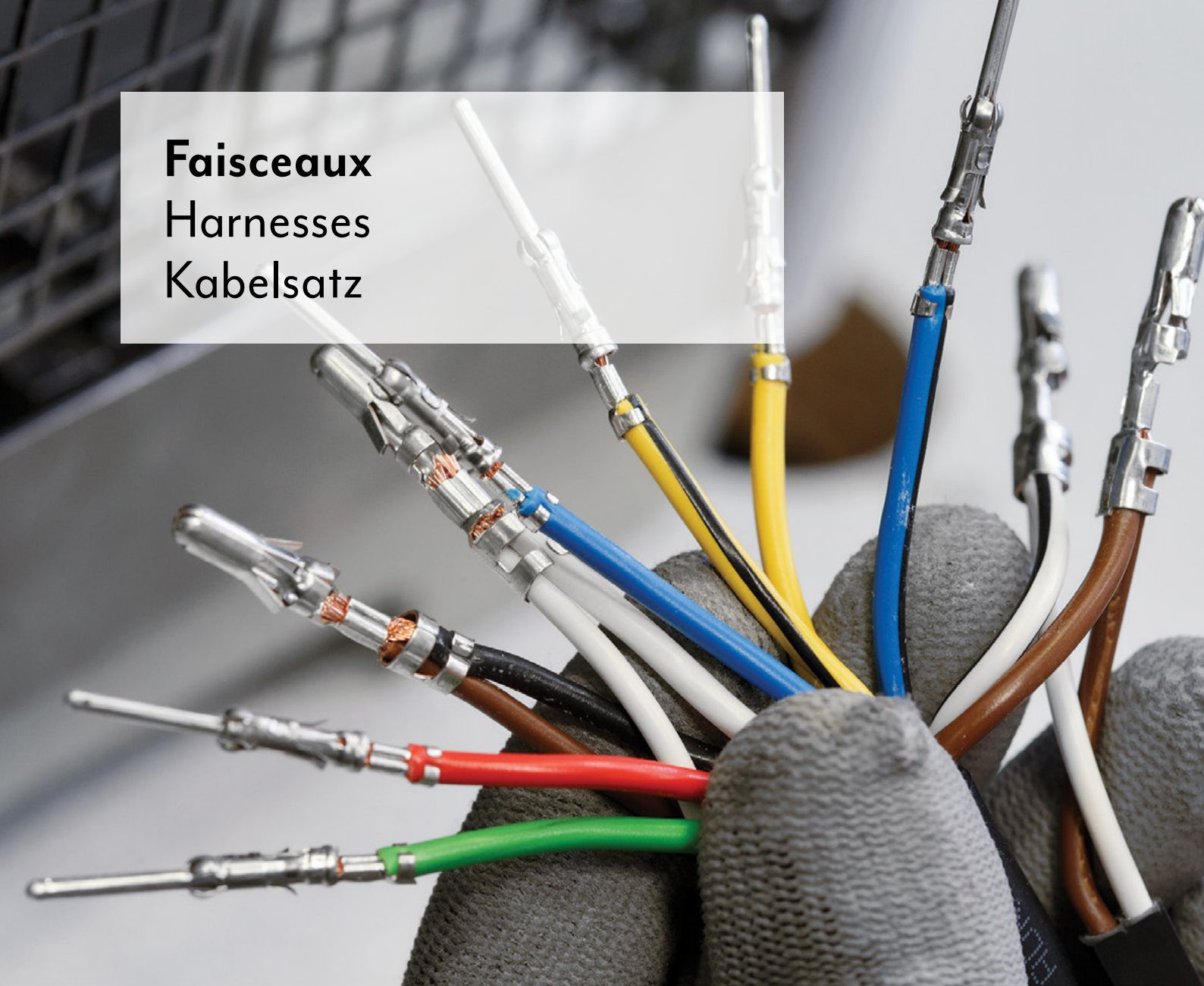

Flashez le QR code pour plus d'infos
Scan the QR code for more info
Scannen Sie den QR-Code für weitere Informationen

AMP 1.5-7P-M

Type connecteur - Nb pins - Mâle ou Femelle
Connector type - Pins Nb - Male or Female
Steckertyp - Stifte Nb - männlich oder weiblich

ADP RSC



ADR



24N 24S / 15P

ADAPTATEURS AVANT - FRONT ADAPTERS - ANSCHLUSSKABEL

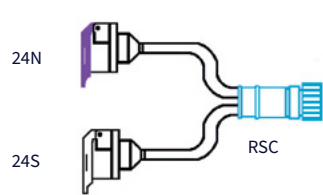

D10504 1000 mm 16V

D13257 1500 mm 15V

Faisceau prises 24N / 24S
Cable with plugs 24N / 24S
Anschlusskabel mit Steckdosen 24N / 24S

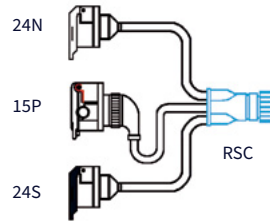

D14780 500 mm 16V

D13256 300 mm 15V

Faisceau prises 15P / 24N / 24S
Cable with plugs 15P / 24N / 24S
Anschlusskabel mit Steckdosen 15P / 24N / 24S

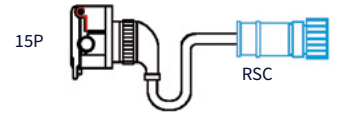

D13254 1000 mm 16V

D13255 600 mm 15V

Faisceau prises 15P
Cable with plugs 15P
Anschlusskabel mit Steckdosen 15P

Comment différencier rapidement les connecteurs RSC ? How to differentiate quickly the RSC connectors? Wie unterscheiden sich die verschiedenen RSC-Stecker ?

Un connecteur RSC 16 voies présente 4 pins centraux alors qu'un connecteur RSC 15 voies en présente 3 (voir schéma ci-contre).

A 16 pins RSC connector has 4 central pins while a 15 pins connector has 3 (see opposite draw).

Ein 16-poliger RSC-Stecker hat 4 zentrale Kontaktstifte, ein 15-poliger RSC-Stecker nur 3 (siehe nebenstehende Skizze).

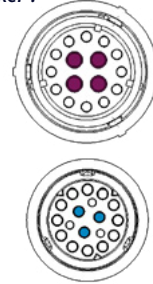

PRL RSC



ADR

CÂBLE D'ALIMENTATION PRINCIPALE - MAIN SUPPLY CABLE - HAUPTKABEL



D10505 16 m 16V

D13263 15 m 15V

Prolongateur RSC simple
Single RSC Main supply cable
Haupt-Verlängerungskabel für RSC

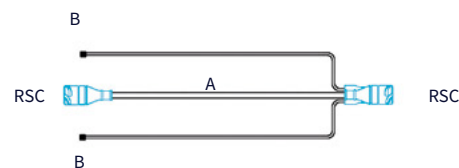

D10510 A: 10 m / B: 10 m 16V

D10508 A: 16 m / B: 16 m 16V

D13260 A: 15 m / B: 0,27 m* 15V

Prolongateur avec câbles plats
Main supply cable with flat cables
Haupt-Verlängerungskabel mit eingegossenem Flachkabel
* avec autopoperants / with click-in / mit click-in



D13249 16V

Connecteur RSC femelle presse étoupe + contacts
Female RSC connector with o'ring + contacts
Weiblicher RSC Stecker mit Kabelverschraubung + Kontakt



D13250 16V

Connecteur RSC mâle presse étoupe + contacts
Male RSC connector with o'ring + contacts
Männlicher RSC Stecker mit Kabelverschraubung + Kontakt



ADR

Exemple de montage p. 272
Assembly suggestion p. 272
Montagebeispiel siehe S. 272

ADAPTATEURS ARRIÈRE - REAR ADAPTERS - ANSCHLUSSKABEL

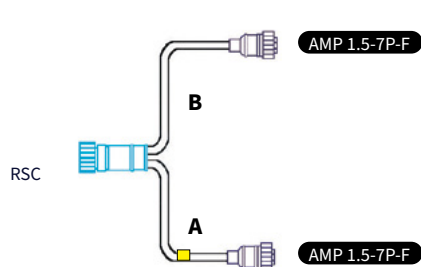

D10513 A: 3,5 m / B: 3,5 m 16V

Faisceau pour feux arrière avec surmoulages droits
Rear lamp cable with straight overmoulding
Leitungssatz für Heckleuchten mit geradem Anschlussstecker
■ = gauche - left - links

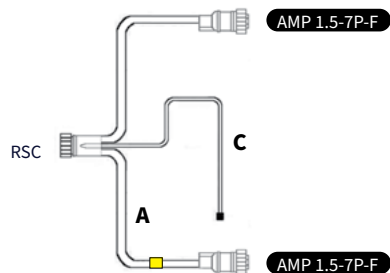

D13262 A: 2,5 m / B: 1,5 m / C: 1,2 m 15V

Faisceau pour feux arrière avec câbles plats et surmoulages droits
Rear lamp cable with flat cables and straight overmoulding
Leitungssatz für Heckleuchten mit geradem Anschlussstecker und Flachkabel für
■ = gauche - left - links

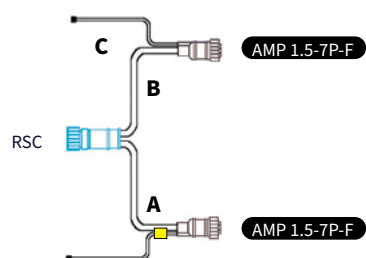

D10514 A/B: 2 m / C: 0,5 m 16V

D10515 A: 1,5 m / B: 2,5 m / C: 16 m 16V

R12499 A: 2,5 m / B: 1,5 m / C: 0,5 m 15V

Faisceau pour feux arrière avec câbles plats et surmoulages droits
Rear lamp cable with flat cables and straight overmoulding
Leitungssatz für Heckleuchten mit Flachkabel und geradem Anschlussstecker
■ = gauche - left - links

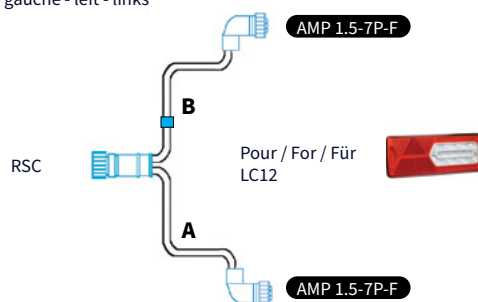

R14407 A: 2 m / B: 2 m 16V

Faisceau pour feux arrière LC12T avec surmoulages coudés
LC12T Rear lamp cable with 90° overmoulding
Leitungssatz für LC12T Heckleuchten mit 90° gewinkelter Stecker
■ = gauche - left - links

LED



⚡ 24V

BOITIER DE COMPATIBILITÉ LED VIGNAL

VIGNAL LED COMPATIBILITY GEAR - VIGNAL-LED-VORSCHALTGERÄT



Fonctions testées : position droit, position gauche, stop
Funzioni testate: posizione destra, posizione sinistra, stop
Funciones probadas : posición derecha, posición izquierda, stop

D13237 fils nus - naked cable extremity - kabellitze

D13502 pour module de jonction - for junction box - für Verteilerbox

D13234 RSC Vignal 16 voies - poles - pölige stecker

D13235 RSC Vignal 15 voies - poles - pölige stecker

MDJ

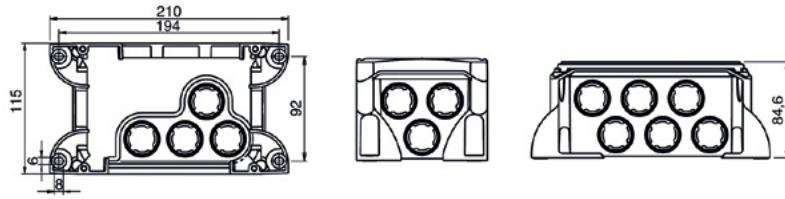

SYSTÈME MDJ - BOX SYSTEM - VERTEILERDOSE



175020

D11889



175086 cable Ø 5,9-6,9

177136 cable Ø 8,3-10

175096 cable Ø 11-12

FCA

Pour feux arrière type LCR19 p.146

For rear lamps LCR19 p.146

Für Heckleuchten vom Typ LCR19 p.146



NEW

D14984

AMP-MCP-4P-F

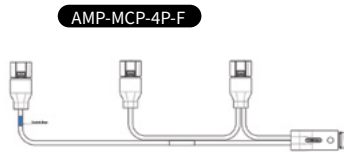

D14980

AMP 1.5-7P-M



D14983

AMP-MCP-4P-F

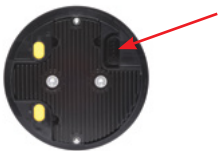

Affectations constructeurs
OE applications
Fahrzeugverwendung

SCHMITZ p.117

AMP-MCP-4P-F

AMP-MCP-4P-F

AMP-MCP-4P-F

AMP-MCP-4P-F

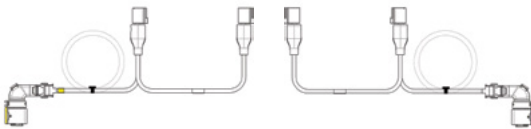

D14846

HDSCS-6P-F

gauche - left - links

D14847

HDSCS-6P-F

droit - right - rechts



D14884

HDSCS-6P-F

gauche - left - links

D14885

HDSCS-6P-F

droit - right - rechts



CÂBLES FEUX ARRIÈRE - REAR LAMP CABLES - ANSCHLUSSKABEL HECKLEUCHTEN



AMP 1.5

Pour feux arrière type LC5, LC6, LC7, LC8, LC9, LC12 p.138

For rear lamps LC5, LC6, LC7, LC8, LC9, LC12 p.138

Für Heckleuchten vom Typ LC5, LC6, LC7, LC8, LC9, LC12 p.138



AMP 1.5-7P-F

D11626 2500 mm

D11627 4300 mm

Pour module de jonction 175020
For junction box 175020
Für Verteilerdose 175020



AMP 1.5-7P-F

D11628 2500 mm

Fils nus
Naked cable extremity
Kabellitze

AMP 1.5

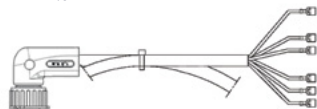

AMP 1.5-7P-F

280049 4000 mm

Fils nus
Naked cable extremity
Kabellitze

RALLONGES - EXTENSION LEADS - VERLÄNGERUNGSSCHNUR



AMP 1.5-7P-M

AMP 1.5-7P-F

D12449 1000 mm

D12450 2000 mm

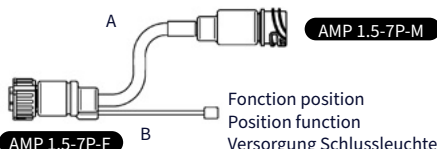

AMP 1.5-7P-M

AMP 1.5-7P-F

Fonction position
Position function
Versorgung Schlussleuchte

R12575 A: 3 m / B: 3 m

R12576* A: 0,5 m / B: 3 m

* Pour / For / Für LC9 p. 167



DOUBLEUR DE FEUX - DOUBLE REAR LAMP CABLE - KABEL FÜR ZWEI RÜCKLEUCHTEN



AMP 1.5-7P-F

AMP 1.5-7P-M

D11689 500 mm



FCA



CAPOT DE PROTECTION - PROTECTIVE COVER - SCHUTZKAPPE

175 mm x 68 mm x 52 mm



D14721

Capot de protection pour connectique coudée feu arrière
Protective cover for rear lamp 90° connector
Schutzkappe für Heckleuchte mit gewinkeltem Stecker

195 mm x 70 mm x 113 mm



D13725

Capot de protection pour connectique droite feu arrière
Protective cover for rear lamp straight connector
Schutzkappe für Heckleuchte mit geradem Stecker

KIT



KITS DE RÉPARATION POUR FEUX ARRIÈRE - REAR LAMPS REPAIR KITS - REPARATURSATZ FÜR HECKLEUCHTEN



D11868

Connecteur AMP 1.5 simple
Single AMP 1.5 connector
Anschlussstecker AMP 1.5

AMP 1.5-7P-F



D11865

Connecteur AMP 1.5 avec câble plat
AMP 1.5 connector with flat cable
Anschlussstecker AMP 1.5 mit Flachkabel

500 mm



ADR



AMP JPT

Pour éclairateurs de plaque EPP98 p. 181 et feux de position SMD98, FE98 et FPL93 p. 197

For number plate lamp EPP98 p. 181 and position lamp SMD98, FE98 and FPL93 p. 197

Für Kennzeichenleuchte EPP98 S.p. 181 und Markierungsleuchten SMD98, FE98 und FPL93 S.p. 197



CÂBLES FEUX LATÉRAUX - SIDE MARKER LAMP CABLES - KABEL FÜR POSITIONSLEUCHTEN AMP JPT



JPT-2P-F

280009 A : 2 m

280019 A : 4 m

280029 A : 6 m

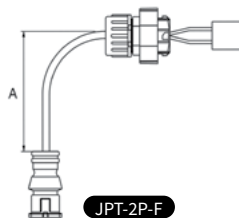

Pour / For / Für
MDJ 175020

JPT-2P-F

280039 A : 4 m

Fils nus
Naked cable extremity
Kabellitze

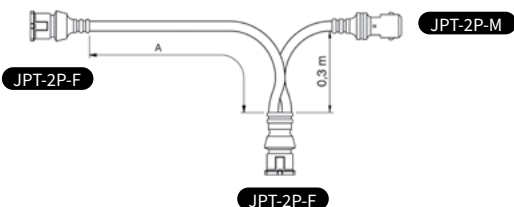

JPT-2P-F

JPT-2P-M

280059 A : 3,5 m

280069 A : 5,5 m

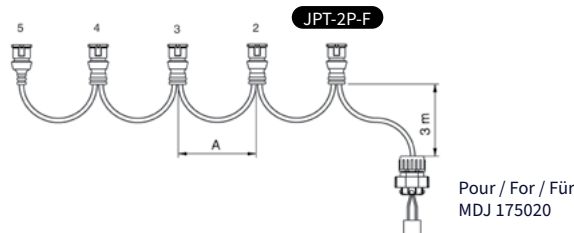

JPT-2P-F

Pour / For / Für
MDJ 175020

3 x JPT	280089	A : 3,5 m	280129	A : 5,5 m
4 x JPT	280099	A : 3,5 m	280139	A : 5,5 m
5 x JPT	280109	A : 3,5 m	280149	A : 5,5 m

KIT

KITS DE RÉPARATION POUR FEUX LATÉRAUX - SIDE MARKER LAMPS REPAIR KITS REPARATURSATZ FÜR POSITIONSLEUCHTEN

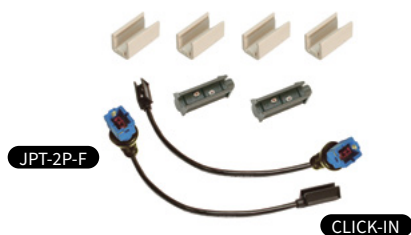

JPT-2P-F

CLICK-IN

001796 500 mm

001806 1500 mm



CLICK-IN

001786 500 mm



JPT-2P-F

D13876

Connecteur JPT 2 voies
2 poles JPT connector
Anschlussstecker 2 polig JPT



CÂBLES FEUX LATÉRAUX - SIDE MARKER LAMP CABLES - KABEL FÜR POSITIONSLEUCHTEN SUPERSEAL

ADR



SUPERSEAL

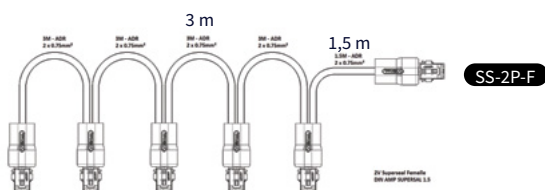

R14173 17,5 m

Pour éclairateurs de plaque LPL18, EPP96LED p. 179 et feux de position SMD98, DX p. 197

For number plate lamp LPL18, EPP96LED p. 179 and position lamp SMD98, DX p. 197

Für Kennzeichenleuchte LPL18, EPP96LED p. 179 und Markierungsleuchten SMD98, DX S.p. 197

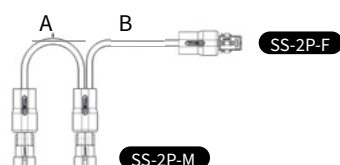

R14418 A : 300 mm/ B:500 mm



R14426 1500 mm

Rallonge SUPERSEAL 2 voies
2 poles SUPERSEAL extension lead
Verlängerungsschnur Anschlussstecker 2 polig



KIT



KITS DE RÉPARATION POUR FEUX LATÉRAUX - SIDE MARKER LAMPS REPAIR KITS REPARATURSATZ FÜR POSITIONSLEUCHTEN



D13880

SS-2P-F

Connecteur SUPERSEAL 2 voies femelle
2 poles female SUPERSEAL connector
Weiblich Anschlussstecker 2 polig

Pour / For / Für
SMD98, FPL93, LC12, ICDL10,
LPL18



D14208

SS-2P-M

Connecteur SUPERSEAL 2 voies mâle
2 poles male SUPERSEAL connector
Männlich Anschlussstecker 2 polig



Câble plat
Flat cable
Flachkabel



D11268 16 m

A10779 100 m

Câble plat - Flat cable - Flachkabel



POS-2P-F

D11147 500 mm

Pour / For / Für
LC8T



Câble plat optionnel avec connecteur 2 voies pour repiquage sur feu arrière LC8

Optional flat cable with 2-pin connector to plug-in LC8 rear lamp

Flachkabel mit 2-polig Anschlussstecker zum direkten Anschluss an die Heckleuchte LC8

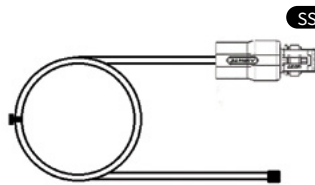

SS-2P-F

Pour / For / Für
LC12T



R14412 16 m

Câble plat optionnel avec connecteur 2 voies SUPERSEAL pour repiquage sur feu arrière LC12T

Optional flat cable with SUPERSEAL 2-pin connector to plug-in LC12T rear lamp

Flachkabel mit SUPERSEAL 2-polig Anschlussstecker zum direkten Anschluss an die Heckleuchte LC12T

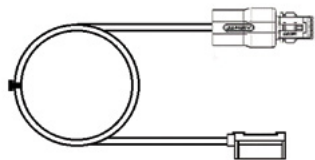

SS-2P-F

CLICK-IN

R14416 1500 mm



R14339 7,5 m

4V DT

Pour / For / Für
CTL15



R14338 7,5 m

4V DT

Pour / For / Für
BL15



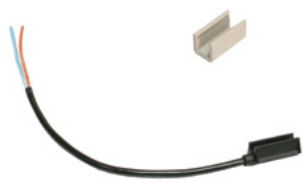

CLICK-IN

D10517 500 mm

D10518 1500 mm

D10519 3500 mm

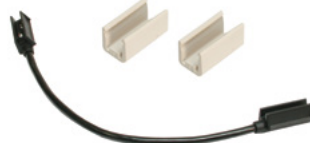

CLICK-IN

D10132 200 mm



151236

Verrou pour click-in à usage unique
Clamp for click-in, single use
Einmal click-in Riegel



001826

Obtuteur seal-in
Seal-in obturator
Verschlusshülse seal-in



9115118

Pince pour click-in
Pliers for click-in
Montagezange für click-in Befestigung



4330012

Bouchon pour câble plat
Cap for flat cable
Abschlussstopfen für Flachkabel



D13251 1 Kg

Graisse anti-corrosion
Anti-corrosion grease
Korrosionsschutzfett

Systemes câblage et feux

Wiring and lamps systems

Verkabelung und Leuchten Systeme

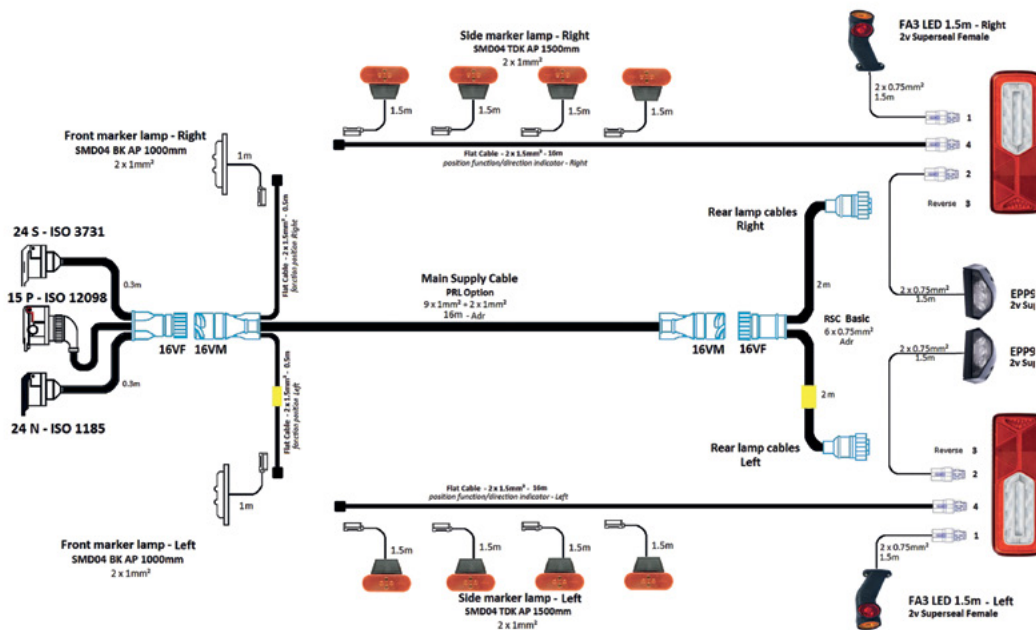
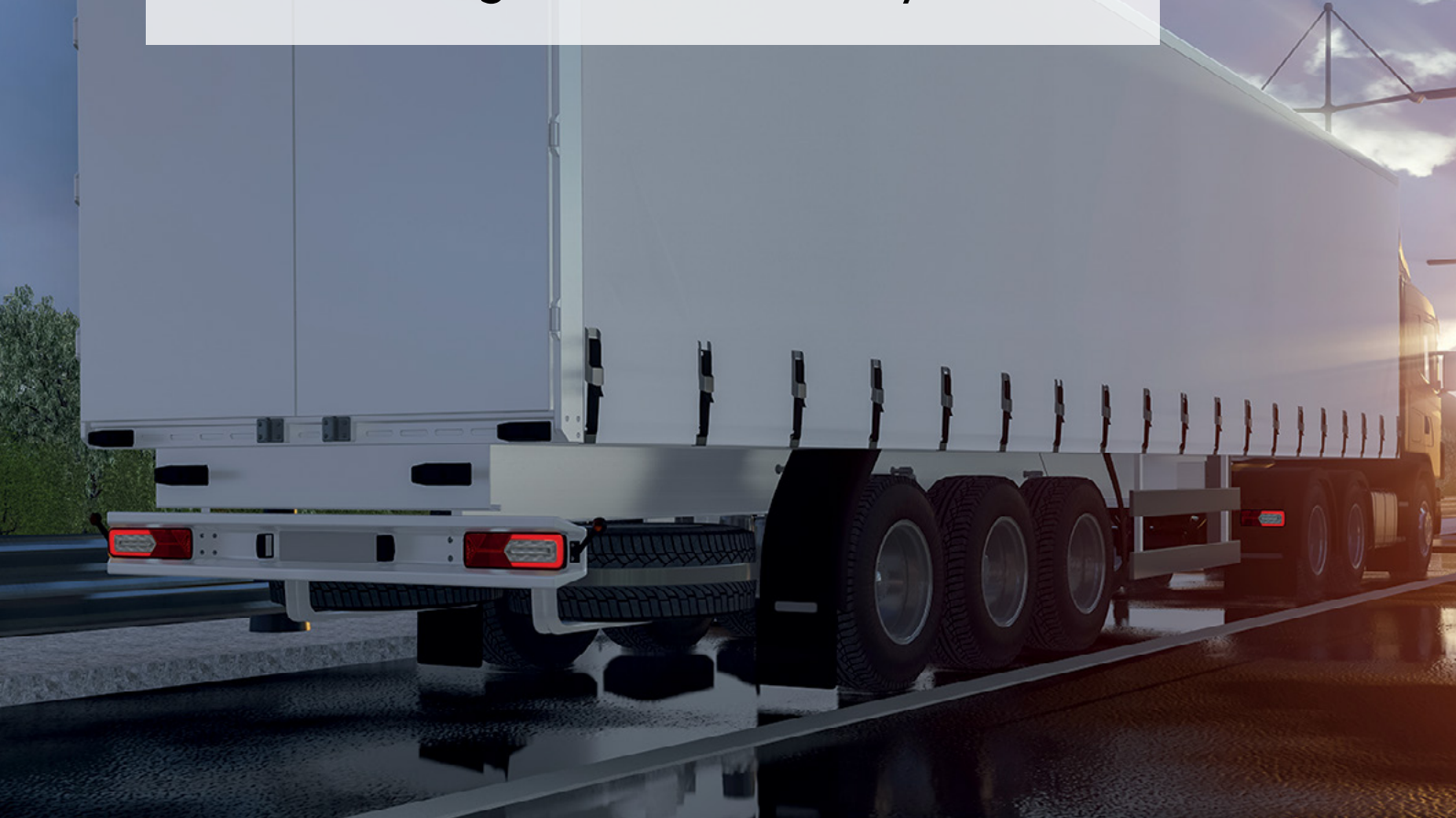

Flashez le QR code pour plus d'infos
Scan the QR code for more info
Scannen Sie den QR-Code für weitere Informationen

AMP 1.5-7P-M

Type connecteur - Nb pins - Mâle ou Femelle
Connector type - Pins Nb - Male or Female
Steckertyp - Stifte Nb - männlich oder weiblich

KITS COMPLETS LED - LED COMPLETE KITS - LED GESAMT-KIT

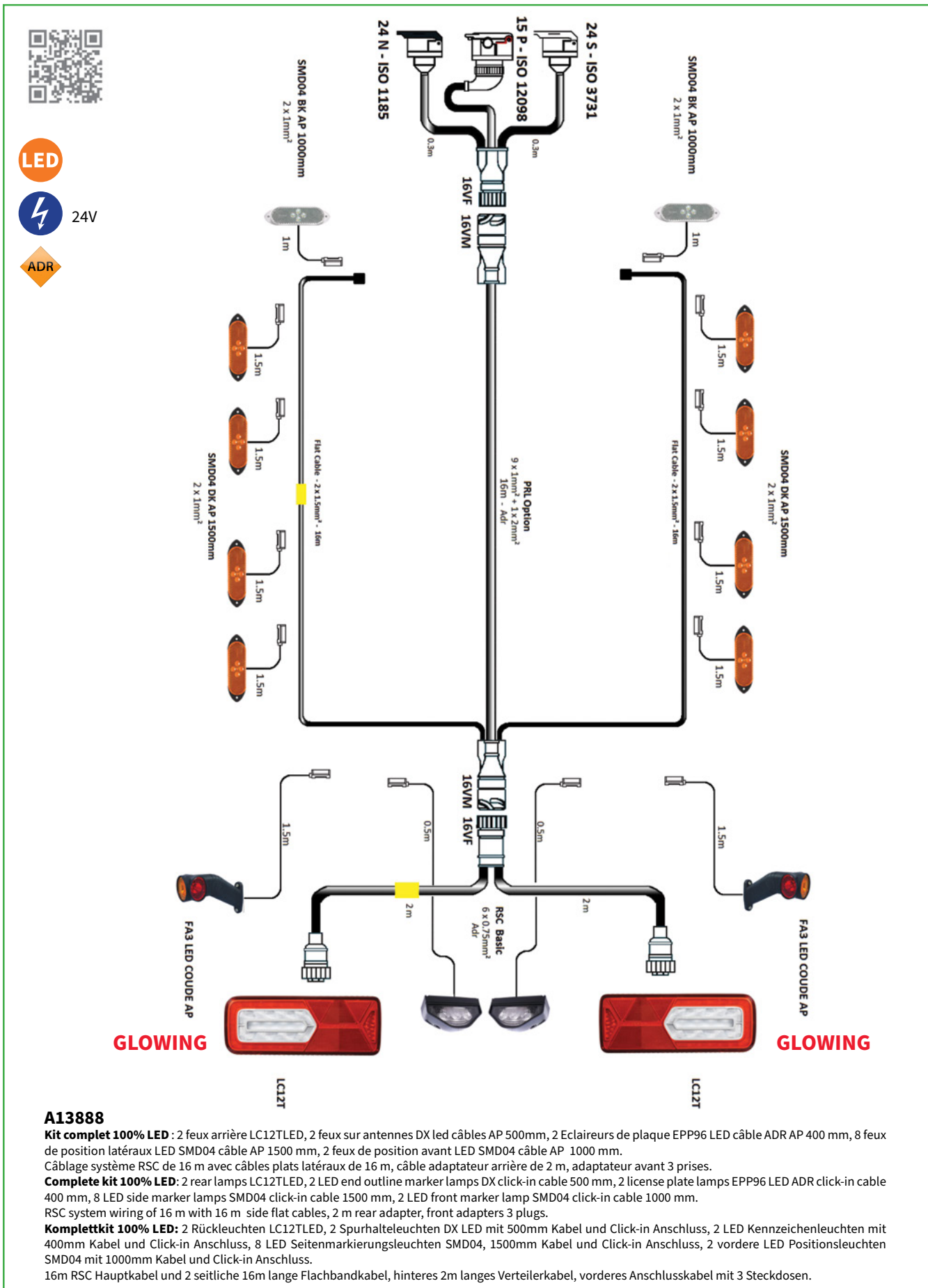

KITS COMPLETS LED - LED COMPLETE KITS - LED GESAMT-KIT



FEUX DE POSITION LATÉRAUX LED CLIGNOTANTS gestion selon supplément 6 - R48
 LED SIDE MARKER FLASHING LAMPS management supp 6 - R48
 LED SEITLICHEN BLINKLEUCHTENT Ansteuerung gemäß der Erweiterung 6 - R48

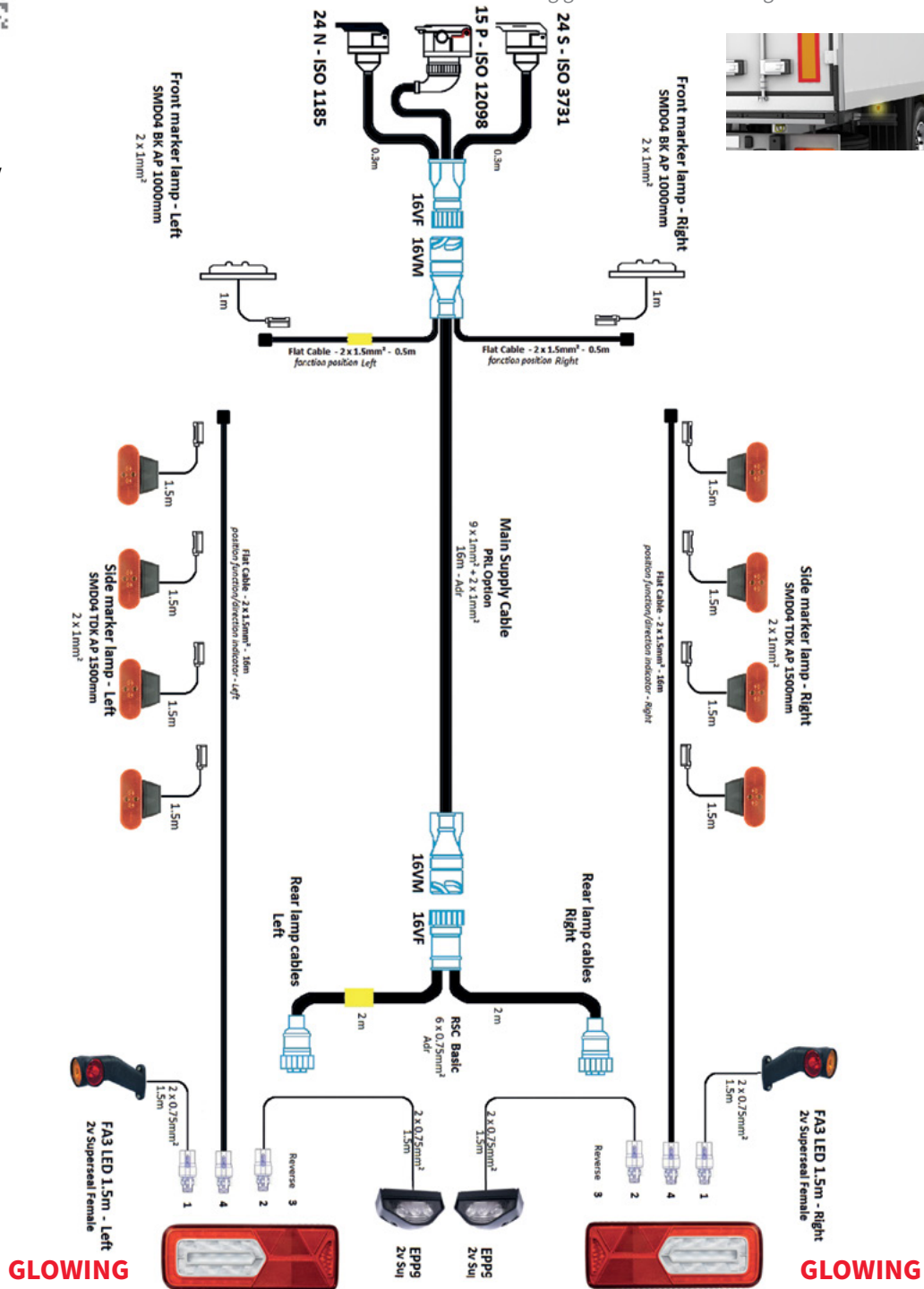

A14366

Kit complet 100% LED : 2 feux arrière LC12TLED, 2 feux sur antennes DX led câbles SS 1,5 m, 2 Eclaireurs de plaque EPP96 LED câble ADR SS 1,5 m, 8 feux de position latéraux clignotants LED SMD04 câble AP 1500 mm, 2 feux de position avant LED SMD04 câble AP 1000 mm.

Câblage système RSC de 16 m avec câbles plats latéraux de 16 m connectique SS, câble adaptateur arrière de 2 m, adaptateur avant 3 prises.

Complete kit 100% LED: 2 rear lamps LC12TLED, 2 LED end outline marker lamps DX cable SS 1,5 m, 2 license plate lamps EPP96 LED ADR cable SS 1,5 m, 8 LED flashing side marker lamps SMD04 click-in cable 1500 mm, 2 LED front marker lamp SMD04 click-in cable 1000 mm.

RSC system wiring of 16 m with 16 m side flat cables SS connector, 2 m rear adapter, front adapters 3 plugs.

Komplettkit 100% LED: 2 Rückleuchten LC12TLED, 2 Spuralleuchte DX LED mit 1,5 m Kabel und SS Anschluss, 2 LED Kennzeichenleuchten mit 1,5 m Kabel und SS Anschluss, 8 LED Seitlichen Blinkleuchtent SMD04, 1500mm Kabel und Click-in Anschluss, 2 vordere LED Positionsluchten SMD04 mit 1000mm Kabel und Click-in Anschluss.

16m RSC Hauptkabel und 2 seitliche 16m lange Flachbandkabel mit SS Anschluss, hinteres 2m langes Verteilerkabel, vorderes Anschlusskabel mit 3 Steckdosen.

KITS COMPLETS - COMPLETE KITS - GESAMT-KIT



24V

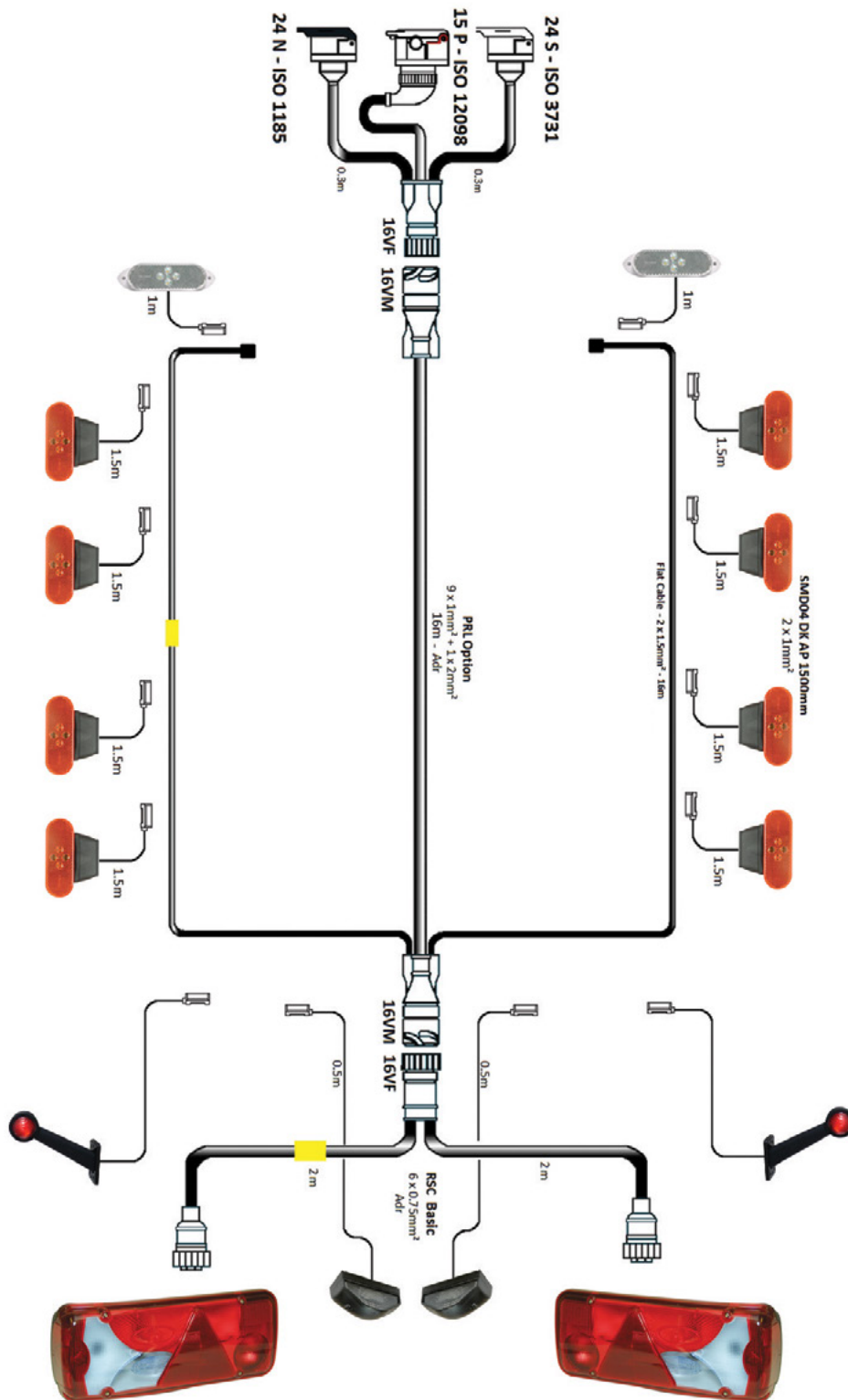

A11212

Kit complet : 2 feux arrière LC8T, 2 feux sur antennes DX câbles AP 600mm, 2 Eclairage de plaque EPP96 câble ADR AP 410 mm, 8 feux de position latéraux LED SMD04 bride coudée câble AP 1500 mm, 2 feux de position avant LED SMD04 câble AP 1000 mm.

Câblage système RSC de 16 m avec câbles plats latéraux de 16 m, câble adaptateur arrière de 2 m, adaptateur avant 3 prises

Complete kit : 2 rear lamps LC8T, 2 end outline marker lamps DX click-in cable 600 mm, 2 license plate lamps EPP96 ADR click-in cable 410 mm, 8 LED side marker lamps SMD04 90° bracket click-in cable 1500 mm, 2 LED front marker lamp SMD04 click-in cable 1000 mm.

RSC system wiring of 16 m with 16 m side flat cables, 2 m rear adapter, front adapters 3 plugs

Komplettkit : 2 Rückleuchten LC8T, 2 Spurhalteleuchten DX mit 600mm Kabel und Click-in Anschluss, 2 Kennzeichenleuchten mit 410mm Kabel und Click-in Anschluss, 8 LED Seitenmarkierungsleuchten SMD04 mit 90° Montagewinkel, 1500mm Kabel und Click-in Anschluss, 2 vordere LED Positionsluchten SMD04 mit 1000mm Kabel und Click-in Anschluss.

16m RSC Hauptkabel und 2 seitliche 16m lange Flachbandkabel, hinteres 2m langes Verteilerkabel, vorderes Anschlusskabel mit 3 Steckdosen.

KITS COMPLETS LED 13P - LED COMPLETE KITS 13P - LED GESAMT-KIT 13P



12V

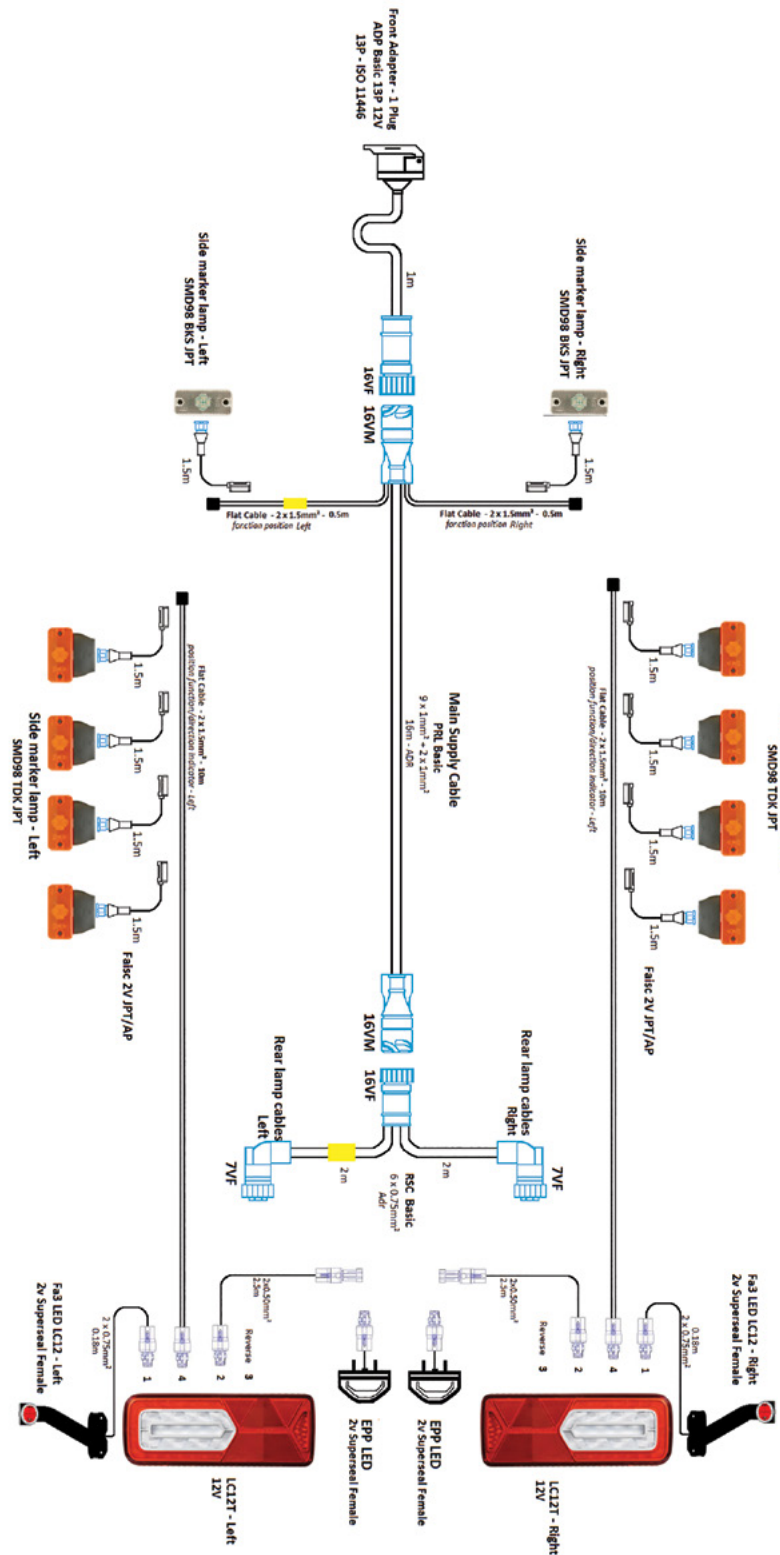

NEW

A14838

Kit complet 100% LED 12V : 2 feux arrière LC12TLED, 2 feux sur antennes FA3 LC12 led câbles SS 1,8 m, 2 Eclairers de plaque BX868 LED câble ADR SS 2 m, 8 feux de position latéraux clignotants LED SMD98 + câble AP 1500 mm, 2 feux de position avant LED SMD98 + câble AP 1500 mm.

Câblage système RSC de 16 m, câbles plats latéraux de 10 m connectique SS, câble adaptateur arrière de 2 m, adaptateur avant 13P ISO1724.

Complete kit 100% LED 12V: 2 rear lamps LC12TLED, 2 LED end outline marker lamps FA3 LC12 led cable SS 1,8 m, 2 license plate lamps BX868 LED ADR cable SS 2 m, 8 LED flashing side marker lamps SMD98 + click-in cable 1500 mm, 2 LED front marker lamp SMD98 + click-in cable 1500 mm.

RSC system wiring of 16 m, 10 m side flat cables SS connector, 2 m rear adapter, front adapter 13P ISO1724.

Komplettkit 100% LED 12V: 2 Rückleuchten LC12TLED, 2 Spurhalteleuchten FA3 LC12 led mit 1,8 m Kabel und SS Anschluss, 2 BX868 LED Kennzeichenleuchten mit 2 m Kabel und SS Anschluss, 8 LED Seitlichen Blinkleuchten SMD98 + 1500mm Kabel und Click-in Anschluss, 2 vordere LED Positionsleuchten SMD98 + 1500mm Kabel und Click-in Anschluss.

16m RSC Hauptkabel, 2 seitliche 10m lange Flachbandkabel mit SS Anschluss, hinteres 2m langes Verteilerkabel, vorderes Anschlusskabel 13P ISO1724.

KITS COMPLETS LED 7P - LED COMPLETE KITS 7P - LED GESAMT-KIT 7P



12V

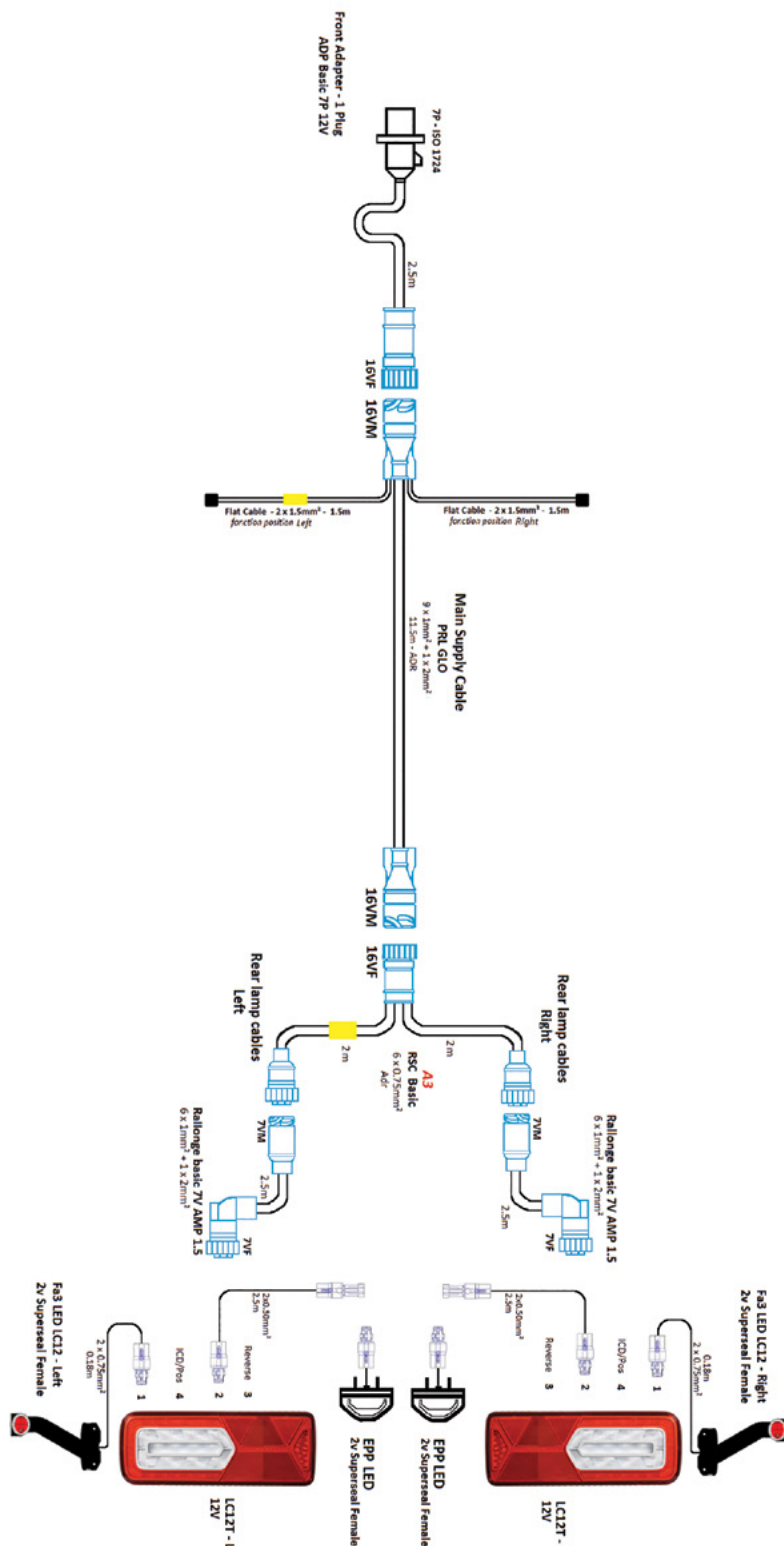

NEW

A14715

Kit complet 100% LED 12V : 2 feux arrière LC12TLED, 2 feux sur antennes FA3 LC12 led câbles SS 1,8 m, 2 Eclairage de plaque BX868 LED câble ADR SS 2 m. Câblage système RSC de 11,5 m, câbles plats latéraux de 1,5 m connectique SS, câble adaptateur arrière de 2 m, adaptateur avant 7P ISO1724.

Complete kit 100% LED 12V: 2 rear lamps LC12TLED, 2 LED end outline marker lamps FA3 LC12 led cable SS 1,8 m, 2 license plate lamps BX868 LED ADR cable SS 2 m. RSC system wiring of 11,5 m, 1,5 m side flat cables SS connector, 2 m rear adapter, front adapter 7P ISO1724.

Komplettkit 100% LED 12V: 2 Rückleuchten LC12TLED, 2 Spurhalteleuchten FA3 LC12 led mit 1,8 m Kabel und SS Anschluss, 2 BX868 LED Kennzeichenleuchten mit 2 m Kabel und SS Anschluss. 11,5m RSC Hauptkabel, 2 seitliche 1,5 m lange Flachbandkabel mit SS Anschluss, hinteres 2m langes Verteilerkabel, vorderes Anschlusskabel 7P ISO1724.

Index : Liste de correspondance - Cross-list - Hersteller-Nr.

	OES	VIGNAL		OES	VIGNAL
BOBCAT	728786	R12931	HEULIEZ	2773801	167150
	7027476	052500		2870801	167150
	7028787	R12934		3156201	067000
	7164110	152150		0190408700	181000
	7164111	152150		0190552400	181050
	7175124	196010		190825600	193020
	7322387	161140		5010104837	185050
	7322388	161150		5010217022	185020
	7322390	D14488		5010271501	195030
	7348957	D14324		5010312524	195060
	7348958	D14325			
	7387145	D14854			
CASE	5141966	198810	IVECO	791123	152180
	47363002	199000		1608352	001726
	47826594	D14191		41200664	193170
	875884890	D14156		41221040	119930
				41221041	119920
CLAAS	27108471	212400	42535711	052500	
	7700027564	196020	42555041	110530	
DAF	0698603	040500	42555042	110520	
	0867930	196010	42555131	D12337	
	1272653	067500	42555132	D12336	
	1284211	167640	42566495	052500	
	1284212	167630	47363002	199000	
	1284213	168100	69500026	D12335	
	1284214	168390	69500032	D12334	
	1304788	168010	69500044	D12341	
	1304789	168020	69500047	D12340	
	1329718	193020	69500590	D12339	
	1401713	152170	69500591	D12338	
	1401731	152180	93161844	067500	
	1403887	195010	97163920	119550	
	1451482	052500	99463242	168600	
	1519368	D12953	99463243	168590	
	1608352	001726	99463244	168610	
	1625985	169160	500308514	193020	
	1625986	169170	500341613	198060	
	1626101	119550	500356782	D11481	
	1626102	001616	500356783	D11482	
	1626319	168100	504097923	193290	
	1626320	168390	580224029	160120	
	1653605	193200	5001834568	001616	
	1660967	168890	5801363428	169390	
	1660968	169380	5801363430	169400	
	1814096	109010	5801363431	169410	
	1815754	109010	5801363432	169420	
	1846491	117000	5801426889	153220	
	1846492	117010	5801426894	153210	
	1875576	155110	5801426912	153200	
	1875577	155100	5801426917	153230	
	1875578	155120	5801426975	153240	
	1875579	155140	5801426977	153250	
	1875580	155130	5801426979	153260	
	1875581	155150	5801572018	110560	
	1914690	055020	5801572024	110550	
	1914691	055030	5801631615	198760	
1973239	001830	5801637182	155480		
2922224	141500	5801637199	155450		
		5801637201	155460		
		5801637202	155470		
		5801757326	155500		
		5801757328	155490		
		5802000568	160080		
		5802000570	160110		
		5802000573	160100		
		5802000767	160090		
		5802000770	160130		
FIAT	1305797	193170			
	71749250	193360			
	1356794080	193360			
	1372698080	153280			
	1372699080	153270			

Index : Liste de correspondance - Cross-list - Hersteller-Nr.

	OES	VIGNAL		OES	VIGNAL	
IVECO	5802000772	160120	MANITOU	223767	152180	
	5802055272	155540		227330	D14517	
	5802055273	160140		564744	052500	
	5802062689	160150		661973	152180	
	5802240291	160150		959694	D14380	
	5802240292	160080		959695	D14381	
	5802240293	160110		52562043	D14380	
	5802240294	160140		52562044	D14381	
	5802240295	160100				
	5802240296	160090		MANITOWOC	03137250	156860
	5802240297	160130			03137251	156870
	A610067-002	052500			03137254	001830
	R504083205	168480			03138527	198660
					03320937	198520
					03320938	152180
	IVECO BUS	504217797		198650		03320939
5000461058		181000		03329492	198640	
5000461059		181050		03329572	D10493	
5001020257		119550				
5001834505		195030	MERCEDES	A 000 826 20 56	056540	
5001834564		001606		DAIMLER	A 000 826 21 56	056550
5001834568		001616			A 906 820 04 64	156340
5001834576		195060			A 906 820 17 64	156350
5001837993		001626			A 910 206 29 00	212010
5001847589		001726			A 910 820 64 00	160400
5010104837		185050			A 910 820 65 00	160410
5010179915		167150			A 910 826 10 00	060000
5010197259		191170			A 910 826 11 00	060010
5010197260		191110			A 910 906 36 00	212010
5010197261		191140			A 910 906 69 00	212420
5010197262		191120			A 949 540 01 04	196170
5010217022		185020			A 956 544 00 11	198780
5010286898		195000			A 956 820 00 59	116200
5010306792		193020			A 959 544 01 03	155590
50101972564		191150			A 959 544 02 03	155600
		A 959 544 03 03	155610			
		A 960 820 02 58	212700			
KUBOTA	W20TS00777	D14513	MERLO	115855	D14479	
	W20TS01401	D14749		115856	D14513	
	W20TS01684	D14725		116119	D14508	
LECAPITAINE	661012	D11689				
	661058	164050				
MAN	7CE945095	155550	NEW HOLLAND	5141966	198810	
	7CE945096	155560		47363002	199000	
	81.25207-6074	212020		47826594	D14191	
	81.25207-6075	212030	51431987	D14654		
	8125225-6033	168090	NISSAN	26164-9X402	119550	
	8125225-6034	168100		26244-9X400	001616	
	8125225-6464	168090		26554-9X126	052500	
	8125225-6469	166700		26555-9X125	152180	
	8125225-6470	166700		26555-9X126	152170	
	8125225-6523	169170		26555-9X128	153120	
	8125225-6524	169160	OPEL	4421269	196010	
	8125225-6526	169180		4421265/6	152180	
	8125225-6528	168490	PEUGEOT CITROËN	9815126980	153280	
	8125225-6530	169190		9815127080	153270	
	8125225-6544	156200		63501FS	153280	
	8125225-6545	156210		6350FS	153270	
	8125225-6547	156220	RENAULT TRUCKS	23811106	212740	
	8125229-6051	067500		23811107	212750	
	8125229-6059	056500		5000296591	166000	
	8125229-6060	056510	5000296591	166100		
MANITOU	163782	500930				
	163783	500940				

Index : Liste de correspondance - Cross-list - Hersteller-Nr.

	OES	VIGNAL		OES	VIGNAL
RENAULT TRUCKS	5000296592	167000	RENAULT TRUCKS	7421430181	104570
	5000296592	167100		7422800385	158030
	5000296593	066000		7422800386	158040
	5000296594	067000		7422800391	058000
	5000296718	088010		7423080010	158050
	5000461058	181000		7423292490	059500
	5000461059	181050		7423374865	D10596
	5000623050	188310		7423467438	159520
	5000807304	040000		7423530438	159520
	5000808166	040500		7423530440	159500
	5000808171	141000		7423530441	159510
	5000808172	141500		7423530442	159530
	5001831194	168220		7425982261	158030
	5001832999	168260		7482252291	115040
	5001834561	195010		7482252506	115000
	5001834565	119450		7482255014	115030
	5001834568	001616		7482266219	113020
	5001835853	168140		7482285707	113030
	5001846843	152000		7482346591	115020
	5001846844	152010		7482367030	115010
	5001846845	152040		7482392733	198620
	5001846846	152050		7482522006	104570
	5001846847	152020		7482586940	198740
	5001846848	152030		7484185589	D14161
	5001846849	152060		7484538758	193020
	5001846850	152070		7484585204	158040
	5001847153	052500		7484585206	158050
	5001847582	169060		7484585208	158030
	5001847583	169070		7485118470	152170
	5001847584	169000		7700353021	196020
	5001847585	169010		7700377130	D14590
	5001847586	169020		7700377208	198510
	5001847587	169030		8200602314	D14593
	5001847588	067500		265100848R	196010
	5001847589	001726		265500292R	152180
	5001847597	119470		265504514R	152180
	5001857964	152510		265550674R	152180
	5001857965	152520		265551402R	152180
	5001858092	152500			
	5001858093	152600	SCANIA	1350343	067500
	5001862030	102200		1365963	168350
	5001862030	193200		1365964	168360
	5001864535	169310		1756751	156780
	5001864536	169320		1756754	156770
	5001870556	152180		1784669	056540
	5010217022	185020		1784670	056550
	5010217023	185040		1791369	156790
	5010271807	185160		2020496	D10596
	5010293829	196010		2021575	156780
	5010306792	193020		2021576	156790
	5010392231	052000		2021578	155020
	5010595381	152170		2021579	156770
	5010595382	152180		2129985	156770
	7420802348	159010		2129986	155020
	7420802350	159020		2129987	156780
	7420802353	159030		2129988	156790
	7420802418	059000		2129991	056550
	7420862032	152880		2129992	056540
	7420862035	152880		2160127	155090
	7420862038	152190		2160128	155080
	7420862041	152200		2340796	155520
	7420894265	193280		2862201	D14852
	7421106206	198650			
	7421137718	104450	SCHMITZ	1302341	161000
	7421268609	191170		1302342	161010
	7421396991	D13019		1348566	D14488

Index : Liste de correspondance - Cross-list - Hersteller-Nr.

	OES	VIGNAL		OES	VIGNAL
SCHMITZ	1364736	161000	VOLVO	21735301	159520
	1364737	161010		23354972	158030
	1370066	161280		23354973	158040
	1370067	161290		23354974	158050
	1415545	213010		23522304	159520
	1415546	213090		23522305	159530
STEYR	48159167	D14156	23522307	159500	
	51431987	D14654	23522308	159510	
			23690764	159520	
UD TRUCKS	84655961	120000	23690765	159530	
	261319Z01B	153860	23690769	159500	
	261319Z01C	153870	23742314	212730	
	261319Z01D	153880	82114500	107010	
	265109Z00A	196010	82114502	107050	
	265509Z00A	052500	82114504	107040	
VF VENIERI	101 1 102	D14548	82114506	107000	
	101 2 421	D14478	82116545	207000	
	101 4 211	D14509	82150539	114010	
	101 4 681	D14508	82151157	111000	
	101 4 734	D14324	82151205	111010	
	101 4 735	D14325	82202076	113000	
VOLKSWAGEN	2E0 945 095 A	156340	82278930	112010	
	2E0 945 096 A	156350	82278938	112000	
	2E0 945 111 A	056540	82348508	116040	
	2E0 945 112 A	056550	82349220	116010	
	7CA 945 091	152180	82349221	116000	
	7CA 945 092	152180	82355678	107000	
	7CA945095	155570	82355684	107010	
	7CA945096	155580	82467736	107500	
			82467737	107510	
VOLVO	20537280	052000	82483073	159510	
	20717520	102200	82483074	159500	
	20721495	196010	82849894	158030	
	20734485	193020	82849905	058000	
	20745060	052500	82849923	158050	
	20745066	001726	82849925	158040	
	20745225	195010	84044658	198740	
	20745227	001616	84122332	059500	
	20769775	159010	84139927	107000	
	20769776	159020	84139939	107010	
	20769777	159030	84185589	D14161	
	20769781	152880	84195505	158030	
	20769782	152880	84195519	158040	
	20769783	152190	84195521	158050	
	20769784	152200	84441759	159500	
	20789440	198620	84441760	159510	
	20802418	059000	84441766	158030	
	20872890	D12111	84441767	158040	
	21087346	207010	84441768	158050	
	21087347	207020	84441936	159520	
	21214524	114020	84441937	159530	
	21214534	114000	84538758	193020	
	21341202	119550	85105029	001766	
	21346521	111020	VOLVO BUS	20480486	198650
	21346522	111030	70364301		198640
	21368779	116050	VOLVO CONSTRUCTION	11170068	198520
	21368781	116060		23374865	D10596
	21368782	116030			
	21368783	116020			
	21396991	D13019			
	21448885	107040			
	21478751	107050			
	21735299	159530			

Index : Références - Part numbers - Artikelnummern

000046	171	094026	199	115030	88	153870	124
000086	188, 212	094036	192	115040	88	153880	124
000176	181, 192, 199, 204, 211,	094046	192	116000	129	153890	124
001586	52, 192, 199, 204	094056	204	116010	129	155020	115, 155
001596	192, 199, 204	094066	204	116020	129	155080	115, 155
001606	58	102200	193, 250	116030	129	155090	115, 155
001616	184, 187	104090	139, 196	116040	129	155100	23, 150
001619	183, 186	104100	139, 196	116050	129	155110	23, 150
001626	40, 54, 55, 56, 59	104130	191	116060	129	155120	23, 150
001696	191, 197, 199, 200, 203	104140	191	116200	78	155130	23, 150
001706	170	104170	202	117000	25, 186	155140	23, 150
001716	191, 197, 199, 200, 203	104180	202	117010	25, 186	155150	23, 150
001726	193, 200, 250	104210	196	119450	187	155450	44, 152
001766	130, 198	104220	196	119470	187	155460	44, 152
001786	309	104250	196	119550	187	155470	44, 152
001796	309	104260	196	119920	47, 183	155480	44, 152
001806	309	104290	190	119930	47, 183	155490	44, 152
001826	312	104300	190	120000	124, 186	155500	44, 152
001830	274	104310	190	141000	171	155520	115, 155
001846	158	104330	202	141500	171	155540	44, 152
001872	153, 274	104340	202	151236	312	155550	70, 153
001916	200	104360	202	152000	100, 104	155560	70, 153
014580	184	104450	190	152010	100	155570	126, 151
040000	171	104510	190	152020	95, 101, 105	155580	126, 151
040500	171	104520	191	152030	101	155590	76
052000	161	104570	190	152040	100	155600	76
052500	162, 163	104640	196	152050	100	155610	76
053700	164, 165	104650	196	152060	101	156040	157
053710	164, 165	104670	196	152070	101	156050	157
055020	150, 151	104680	202	152130	161	156060	157
055030	150, 151	104690	191	152140	161	156070	157
055040	152	104700	196	152150	161	156130	157
055050	152	104710	202	152160	161	156200	70, 153
056000	154	104720	191	152170	161	156210	70, 153
056010	154	107000	128, 131, 185	152180	161	156220	70, 153
056020	156	107010	128, 131, 185	152190	161	156250	32, 66, 159
056030	156	107040	128, 131, 185	152200	161	156260	32, 66, 159
056500	153, 154	107050	128, 131, 185	152500	95, 105	156290	154
056510	153, 154	107500	131, 185	152510	95, 105	156300	62, 154
056540	155, 156	107510	131, 185	152520	95, 105	156310	62, 154
056550	155, 156	109010	24, 186	152600	104	156340	77, 126, 156
056700	158	110520	183	152880	100, 104, 133	156350	77, 126, 156
056710	158	110530	183	153000	164	156380	66, 159
056720	159	110550	183	153010	164	156390	66, 159
056730	159	110560	183	153020	164	156540	20, 154
058000	142	111000	127, ,185	153030	164	156550	20, 154
059000	160	111010	127, ,185	153040	164	156590	156
059500	143	111020	127, ,185	153050	164	156600	156
060000	140, 141	111030	127, ,185	153060	164	156630	157
060010	140, 141	112000	128	153070	164	156640	157
066000	170	112010	128	153120	81, 161	156770	115, 155
066500	170	112110	211	153130	66, 164	156780	115, 155
067000	166, 167, 168	112120	211	153200	45, 163	156790	115, 155
067500	166, 167, 168	112130	211	153210	45, 163	156860	75
067600	169	112140	211	153220	45, 163	156870	75
067610	169	112710	211	153230	45, 163	158030	86, 127, 142
080026	195	112720	211	153240	45, 163	158040	86, 127, 142
080046	195	113000	129	153250	45, 163	158050	86, 127, 142
087020	194	113020	88	153260	45, 163	159010	87, 132, 160
087030	205	113030	88	153270	34, 85, 162	159020	87, 132, 160
087040	188, 201	114000	128	153280	34, 85, 162	159030	87, 132, 160
088010	211	114010	128	153660	165	159500	87, 99, 131, 143
094016	199	114020	128	153670	165	159510	87, 99, 131, 143
		115000	88	153700	165	159520	87, 99, 131, 143
		115010	88	153710	165	159530	87, 99, 131, 143
		115020	88	153860	124	160080	43, 140

Index : Références - Part numbers - Artikelnummern

160090	43, 140	168390	27	193360	200	213070	146
160100	43, 140	168480	47, 167	194010	199	213090	117, 146
160110	43, 140	168490	71	194020	199	213150	146
160120	43, 140	168590	48, 51, 53, 167	194030	199	213160	146
160130	43, 140	168600	47, 51, 53, 167	194070	199	213200	146
160140	43, 140	168610	47, 48, 49, 167	194080	199	240346	216
160150	43, 140	168770	169	194090	199	240356	216
160400	77, 141	168780	169	194130	192	240366	216
160410	77, 141	168790	169	194140	192	241346	216
161000	138	168800	169	194150	192	241356	216
161010	138	168830	169	194190	192	241366	216
161120	138	168890	24	194250	204	280009	309
161130	138	169000	90, 94, 100	194260	204	280019	309
161140	14	169010	90, 94, 100	194270	204	280029	309
161150	14	169020	90, 94	194310	204	280039	309
161180	138	169030	90, 94	195000	58	280049	307
161190	138	169060	91, 96	195010	193	280059	309
161200	138	169070	91, 96	195030	193	280069	309
161210	138	169160	24, 71, 167	195060	205	280089	309
161260	61, 138	169170	24, 71, 167	196010	181	280099	309
161270	61, 138	169180	71, 167	196020	181	280109	309
161280	82, 117, 138	169190	71, 167	196170	181	280129	309
161290	82, 117, 138	169310	90, 94	198010	198	280139	309
161420	138	169320	90, 94	198020	198	280149	309
161430	138	169380	24	198030	198	300000	64, 250
161460	138	169390	46, 168	198040	192	300010	64, 250
161470	138	169400	46, 168	198050	192	500930	73, 175
161500	138	169410	46, 168	198060	203	500940	73, 175
161510	138	169420	46, 168	198510	197	521010	195
161560	138	175020	306	198520	197	521050	195
161570	138	175086	306	198530	197	610080	210
163010	148	175096	306	198540	197	611010	210
164000	19, 144	177136	306	198580	107	611020	210
164010	19, 65, 144	180010	195	198620	88, 130, 198	611070	295
164020	123, 144	180040	195	198640	203	611080	295
164030	123, 144	181000	212	198650	197	611110	295
164050	65	181050	188	198660	191	611140	295
165020	19, 65, 144, 229	181070	188	198690	191	611150	295
165030	19, 65, 144, 229	185010	194	198740	88, 130, 198	611410	296
165040	35, 123, 144, 229	185020	194	198760	78, 197	611500	294
165050	35, 123, 144, 229	185030	205	198810	197	611510	294
166000	170	185040	187	199000	16, 80, 179	611520	294
166100	170	185050	205	199020	179	611530	294
166500	39, 55	185160	187	199030	179	611540	294
166600	170	187120	194	199040	62, 179	611550	294
166700	72	187130	205	207000	129, 132	611560	297
167000	166	187140	188, 201	207010	129, 132	611570	297
167100	166	187720	194	207020	129, 132	611580	294
167150	39, 56	187730	205	212010	77, 253	611590	294
167500	166	187760	188, 201	212020	70, 252	624016	216
167530	169	188010	211	212030	70, 252	624026	216
167550	169	188110	211	212120	252	624036	216
167600	166	188210	211	212160	252	630100	274
167630	24	188310	211	212170	253	630110	274
167640	24	188610	211	212400	22, 252	630120	274
168010	24, 168	188710	211	212420	29, 77, 114, 252	672410	201
168020	24, 168	191110	59	212460	42, 252	725002	173, 174
168090	71, 166	191120	59	212470	252	725010	173
168100	27, 71, 166	191140	59	212520	74, 253	725012	173, 174
168140	95	191150	59	212560	253	725020	173
168220	91, 95, 112	191170	59, 102	212570	253	725022	173, 174
168260	91, 95, 112	193020	200	212710	76, 253	725032	173, 174
168270	166	193170	200	212730	130, 253	725040	173
168340	166	193200	193	212740	86, 253	726290	174
168350	116	193280	200	212750	86, 253	726300	174
168360	116	193290	200	213010	117, 146	726310	173

Index : Références - Part numbers - Artikelnummern

726320	173	D11578	296	D13710	191	D14328	276
726350	174	D11626	307	D13713	197	D14331	301
726450	174	D11627	307	D13725	308	D14345	149
726460	174	D11628	307	D13807	274	D14347	277, 279
4330012	312	D11689	307	D13808	274	D14348	149
9115118	312	D11865	308	D13810	274	D14352	302
60760541	175	D11868	300, 308	D13816	149	D14353	272
60760551	175	D11888	181	D13817	148	D14354	272
67513361	175	D11889	306	D13860	272	D14357	239
67513371	175	D11899	210	D13862	272	D14358	239
67513380	175	D12111	130, 237	D13863	272	D14362	196, 301
67513390	175	D12334	50, 172	D13874	180	D14380	73
A10060	296	D12335	50, 172	D13875	207	D14381	73
A10061	296	D12336	50, 172	D13876	300, 309	D14387	228
A10062	297	D12337	50, 172	D13877	300	D14421	207
A10064	296	D12338	50	D13878	300	D14422	207
A10065	297	D12339	50	D13879	300	D14423	207
A10066	297	D12340	50	D13880	301, 310	D14424	207
A10779	311	D12341	50	D13881	282	D14425	139, 207
A11212	316	D12390	220	D13889	296	D14426	139, 207
A13888	314	D12428	209	D14030	207	D14427	207
A14366	315	D12429	209	D14031	207	D14428	207
A14420	123, 145	D12430	165, 209	D14034	207	D14429	207
A14715	318	D12449	307	D14035	207	D14430	207
A14838	317	D12450	307	D14037	158, 208	D14431	207
D10132	312	D12471	165, 209	D14038	158, 208	D14432	207
D10227	181	D12472	165, 209	D14039	158, 208	D14434	302
D10493	197	D12473	165, 209	D14040	158, 208	D14435	302
D10494	197	D12488	236	D14063	277	D14436	302
D10495	197	D12699	196	D14091	281	D14437	302
D10496	197	D12711	158, 209	D14116	180	D14447	227
D10497	197	D12712	158, 209	D14148	282	D14451	259
D10498	197	D12713	215	D14156	236	D14452	259
D10499	203	D12714	215	D14159	236	D14453	259
D10500	191	D12715	215	D14160	227	D14454	262
D10502	181	D12867	197	D14161	227	D14455	262
D10503	210	D12953	160, 168, 274	D14165	247	D14456	262
D10504	304	D13019	237	D14166	247	D14457	262
D10505	304	D13034	158, 209	D14167	246	D14462	260
D10508	304	D13035	158, 209	D14170	301	D14463	260
D10510	304	D13205	215	D14188	149	D14464	260
D10513	305	D13206	215	D14189	149	D14465	260
D10514	305	D13207	215	D14190	272	D14466	260
D10515	305	D13234	305	D14191	234	D14467	261
D10517	312	D13235	305	D14192	234	D14468	261
D10518	312	D13237	305	D14195	277, 279	D14469	261
D10519	312	D13249	304	D14208	301, 210	D14470	261
D10596	217	D13250	304	D14214	300	D14471	261
D10597	297	D13251	312	D14216	277	D14472	267
D10642	210	D13254	304	D14236	277	D14473	267
D10643	210	D13255	304	D14249	239	D14474	267
D10800	210	D13256	304	D14250	239	D14475	262
D10839	176	D13257	304	D14311	297	D14476	262
D10840	176	D13260	304	D14312	295	D14477	261
D10841	176	D13262	305	D14313	295	D14478	261
D10873	294	D13263	304	D14314	295	D14479	261
D10874	294	D13277	210	D14315	296	D14480	261
D11147	210, 311	D13288	161	D14316	295	D14481	262
D11268	190, 311	D13502	305	D14320	243	D14482	257
D11399	191	D13609	180	D14321	243	D14483	257
D11400	203	D13610	180	D14322	243	D14484	257
D11479	50, 172	D13617	282	D14323	243	D14485	257
D11480	50, 172	D13620	283, 285	D14324	242	D14486	257
D11481	50, 172	D13621	283, 285, 288	D14325	242	D14487	255
D11482	50, 172	D13622	283, 285, 288	D14326	277, 279	D14488	255
D11487	296	D13624	210	D14327	282	D14489	255

Index : Références - Part numbers - Artikelnummern

D14490	255	D14578	296	D14749	260	D14935	270
D14491	255	D14587	216	D14750	260	D14942	298
D14492	255	D14588	216	D14751	260	D14943	298
D14493	255	D14589	216	D14752	255	D14944	298
D14494	255	D14590	216	D14753	255	D14945	298
D14495	255	D14591	216	D14754	255	D14947	298
D14496	255	D14592	216	D14755	255	D14948	298
D14500	254	D14593	216	D14756	254	D14949	298
D14501	254	D14594	216	D14757	254	D14950	298
D14502	254	D14595	216	D14758	254	D14951	298
D14503	254	D14596	216	D14759	220	D14955	290
D14504	267	D14598	249	D14760	269	D14956	290
D14505	267	D14649	244	D14762	269	D14963	241
D14506	267	D14653	239	D14769	239	D14964	241
D14507	256	D14654	236	D14770	239	D14965	226
D14508	256	D14655	207	D14771	239	D14966	226
D14509	256	D14673	246	D14778	260	D14967	226
D14510	256	D14677	286	D14779	255	D14968	224
D14511	263	D14678	288	D14780	304	D14970	222
D14512	263	D14679	288	D14781	208	D14971	223
D14513	263	D14680	286	D14782	208	D14980	147
D14514	233, 263	D14681	288	D14802	296	D14983	147
D14515	263	D14682	288	D14803	279	D14984	147
D14517	181	D14683	288	D14804	279	D14985	179
D14518	177	D14684	288	D14805	278	D14989	270
D14523	177	D14685	285, 288	D14806	280	D14990	216
D14524	177	D14689	296	D14807	283	D14991	216
D14525	177	D14690	246	D14808	283	D14993	246
D14526	177	D14706	214	D14811	220	D14995	290
D14527	177	D14707	214	D14824	296	D23300	266
D14532	214	D14708	214	D14846	147	D23301	266
D14533	214	D14709	214	D14848	118	D23400	266
D14534	214	D14710	214	D14849	118	D23401	266
D14535	214	D14711	214	D14850	222	D23500	266
D14536	214	D14712	214	D14851	223	D23501	266
D14537	292	D14713	214	D14852	223	D23600	266
D14538	292	D14714	215	D14853	225	D23601	266
D14539	292	D14715	215	D14854	225	R12486	301
D14540	230	D14716	215	D14855	225	R12499	305
D14541	230	D14721	308	D14856	223	R12575	307
D14542	231	D14722	196	D14857	139, 147, 219	R12576	307
D14543	231	D14724	254	D14858	219	R12931	15
D14544	231	D14725	254	D14879	196	R12934	15
D14545	231	D14726	254	D14880	219	R14173	310
D14546	231	D14727	256	D14882	277	R14338	311
D14547	232	D14728	256	D14884	147	R14339	311
D14548	232	D14729	256	D14885	147	R14364	139, 180
D14549	233	D14730	256	D14900	285	R14407	305
D14550	233	D14731	256	D14901	285	R14412	311
D14551	233	D14732	257	D14902	285	R14413	301
D14552	232	D14733	257	D14903	284	R14416	311
D14553	232	D14734	257	D14904	284	R14418	310
D14554	232	D14735	257	D14905	279	R14426	310
D14555	220	D14736	257	D14906	277	SHD 8000 LED	228
D14556	220	D14737	258	D14915	281		
D14557	234	D14738	258	D14916	282		
D14558	234	D14739	258	D14922	270		
D14565	263	D14740	258	D14925	269		
D14566	263	D14741	258	D14926	269		
D14567	249	D14742	258	D14928	270		
D14568	249	D14743	235	D14929	270		
D14569	249	D14744	235	D14930	270		
D14574	295	D14745	235	D14931	270		
D14575	295	D14746	259	D14932	270		
D14576	297	D14747	254	D14933	270		
D14577	296	D14748	260	D14934	270		

N° d'homologation - Homologation number - Homologationsnummer

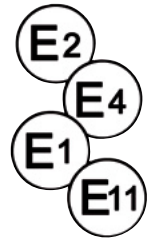

E2	253	MILI	175	E2	86710	FE87	194
E13	697	FRR	176	E2	86711	FE87	205
E13	698	FRR	176	E2	88017	LC7	166
E2	781	FE80	195	E2	88033	LC6	170
E9	1084	672	201	E2	88034	LC6	170
E2	1295	SMD00	198	E2	88035	LC7	167
E1	1559	BBS516	175	E2	88714	FE88	211
E2	2040	LC8	152	E2	88731	MILI	175
E13	2060	725	172	E2	90711	FE81	188
E2	2065	SMD98	203	E2	91098	LC4	171
E3	2617	2751	181	E2	91099	LC4	171
E4	4052	FRR	149	E2	91715	FE80	195
E2	4054	FPL93	200	E2	92057	FM91	59
E2	4088	FE98	192	E2	92058	FM91	59
E2	4089	FE98	192	E2	92059	FM91	59
E2	4090	FE94	203	E2	92060	FM91	59
E2	4091	FE94	203	E2	92061	FM91	59
E2	4092	FE94	198	E2	92062	FM91	59
E2	4093	FE98	198	E13	0001	R104	215
E2	4701	FE87	201	E13	0002	R104	215
E2	4703	FE87	188	E2	0050	C199	183
E2	5047	ICDL94	187	E11	010002	R70	214
E2	5052	FE95	193	E24	020078	FE12	211
E2	5126	FE95	205	E20	020889	DX	210
E9	6653	FRR	149	E2	04010	SMD98	191
E2	7001	EPP96	181	E2	04075	LC9	160
E2	7001	EPP98	181	E2	05010	FE04	190
E2	7102	FE02	193	E2	05011	FE04	202
E2	7139	ICDL94	187	E2	05021	SMD04	196
E11	7573	2963	220	E2	05022	SMD04	191
E2	8005	LC5	161	E2	05023	SMD04	202
E2	8040	SMD98	197	E2	06018	C105	183
E13	8434	725	172	E2	06024	LC5T	164
E2	9033	FE85	187	E2	07089	SH3	220
E2	9036	FE85	205	E2	07092	DXLC8	209
E2	9037	FE85	194	E2	08028	SRD07	185
E2	9056	LC7T	169	E2	09025	ICDL07	186
E2	10035	DX	210				
E2	10073	SRD08	185				
E2	10113	LC9 LED	142				
E13	10989	BX868	180				
E2	11017	EPP96LED	180				
E2	11128	ICDL10	186				
E9	11734	SLIM	148				
E2	12007	LC8	150				
E2	12056	C105	183				
E2	12164	LC10 LED	143				
E4	13992	FRR	149				
E2	14010	DX	207				
E2	14085	LC11	140				
E2	14086	LC11	140				
E2	16005	CTL15	144				
E2	16007	BL15	144				
E2	16027	LC12 LED	138				
E2	16059	ICDL15	186				
E2	16111	CTL14	148				
E2	18042	LC12G LED	138				
E2	19014	LPL18	179				
E2	19106	LCR19	146				
E2	19140	SL1000	219				
E2	20078	RL1500	219				
E4	23271	FRR	149				
E3	38553	2711	177				
E2	5108	MILI	175				
E13	51788	725	173				
E1	53329	BBS516	175				

Index images - pictures - Abbildung

Feux arriere - Rear lamps - Heckleuchten

p. 137-177



Eclaireurs de plaque - Number plate lamps - Kennzeichenleuchten

p. 178-181



Feux clignotants - Flasher lamps - Fahrtrichtungsanzeiger

p. 182-188



Feux de position - Position lamps - Positionsleuchten

p. 189-205



Feux de gabarits - End outline marker lamps - Begrenzungsleuchten

p. 206-212



Signalisation passive - Warning products - Warnmarkierungen

p. 213-217

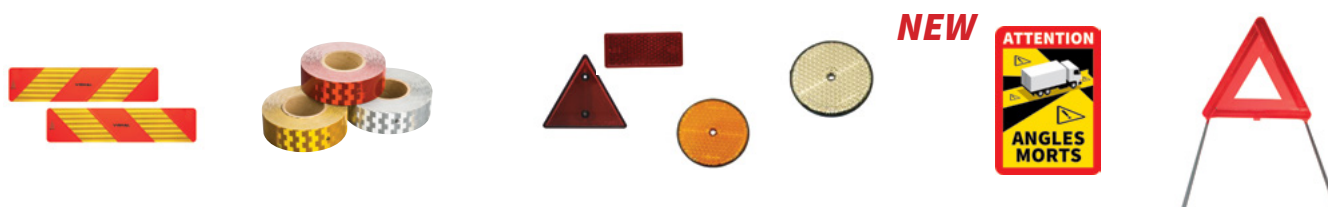

Phares de recul - Reverse work lights - Rückfahrlicht Arbeitsscheinwerfer

p. 218-220



Phares de travail - Work lights - Arbeitsscheinwerfer

p. 221-237



Index images - pictures - Abbildung

Éclairage de sécurité - Warning lights - Sicherheitsbeleuchtungen

p. 238-239



Phares de conduite - Headlights - Fahrlichter

p. 240-244

NEW



Feux auxiliaires - Auxiliary lights - Zusatzsscheinwerfer

p. 245-247



Éclairage intérieur - Interior lights - Innenraum-Beleuchtungen

p. 248-250



NEW



Gyrophares - Beacons - Rundumkennleuchten

p. 251-263



Rampes lumineuses - Lightbars - Warnbalken

p. 264-267

NEW

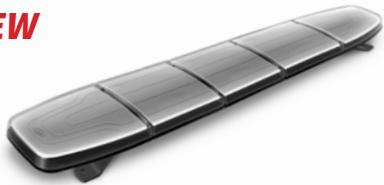

Triflash

p. 268-270



Feux de pénétration - Directional lights - Warnleuchten

p. 271-272



Index images - pictures - Abbildung

Alarmes sonores de recul - Back-up alarms - Rückfahrwarner

p. 273-274

Standard



Multi-Frequency



Systemes caméras - Camera systems - Kamera-Systeme

p. 275-290



Coffres porte extincteur - Extinguisher boxes - Feuerlöscherbehälter

p. 291-292



Produits électriques-électroniques - Electrical-electronic products - Elektrisch-elektronische Produkte

p. 293-318



MISE EN GARDE SUR LES RISQUES JURIDIQUES DE LA CONTREFAÇON
WARNING ON LEGAL RISKS OF ORIGINAL PARTS COPIES / FORGERY
HINWEIS AUF DIE RECHTLICHEN RISIKEN BEI FER VERWENDUNG

MISE EN GARDE SUR LES RISQUES JURIDIQUES DE LA CONTREFAÇON DES PIÈCES D'ORIGINE

Les **remplacements** ou **modifications** de composants autres que ceux montés et recommandés par le constructeur peuvent remettre en cause la sécurité des usagers de la route (diminution des performances photométriques).

Ex : **Le montage d'un cabochon adaptable sur un feu d'origine Vignal est interdit.**

Toute opération de ce type sur le matériel sera **à la charge entière de celui qui sera intervenu** et pourra **remettre en cause** l'homologation du véhicule délivrée par les autorités compétentes.

Le fabricant dégage sa responsabilité réglementaire.

La contrefaçon et la concurrence déloyale de pièces sont condamnées par la loi civile et pénale :

- La contrefaçon engage la responsabilité civile et pénale du fabricant, du revendeur, voire dans certains cas de l'utilisateur des pièces de contrefaçon.

- La concurrence déloyale engage la responsabilité civile du fabricant et du revendeur de copies serviles; en tirant de cette opération un avantage injustifié, **il fausse les règles normales de la concurrence** et réalise de ce fait **un acte de parasitisme** en détournant le travail de recherche et de conception, ainsi que le savoir-faire des constructeurs.

WARNING ON LEGAL RISKS OF ORIGINAL PARTS COPIES / FORGERY

The **remplacements** or **modifications** of components other than those assembled and recommended by the manufacturer can reduce the safety of the road users (reduction in the photometric performances).

Ex : **The assembly of an adaptable lens on an original lamp Vignal is prohibited.**

Any operation of this type on the material **will be judged as responsibility of who intervened** and will **compromise the homologation of the vehicle** delivered by the authorities.

The manufacturer declines all responsibilities.

The forgery and the unfair competition of original parts are condemned by the civil and penal law :

- The forgery engages the civil and penal liability of the manufacturer and the retailer, even in certain cases of the user of the forgery parts.

- The unfair competition engages the civil liability of the manufacturer and the retailer of forged parts; by taking an unjustified advantage from this operation, the forgery **distorts the normal rules** of competition and carries out an **act of parasitism** by diverting the design and R&D task, as well as know-how of the manufacturers.

HINWEIS AUF DIE RECHTLICHEN RISIKEN BEI FER VERWENDUNG VON NACHBAUTEILEN ANSTELLE VON ORIGINALERSATZTEILEN

Der **Austausch** oder die **Modifikation** von Teilen, die nicht in der Erstausrüstung montiert und vom Hersteller empfohlen wurden, können die Sicherheit der Verkehrsteilnehmer beeinträchtigen (Verringerung der lichttechnischen Leistung).

Beispiel: **Die Verwendung einer nachgebauten Lichtscheibe auf einer VIGNAL-Heckleuchte ist nicht zulässig.**

Jede Verwendung dieses Materials wird **zu Lasten des Verwenders** ausgelegt und kann die **Zulassung des Fahrzeugs durch die Zulassungsstellen in Frage stellen.**

Der Fahrzeughersteller entzieht die gesetzliche Gewährleistungspflicht.

Die Fälschung (Nachbau) von Originalteilen und der unlautere Wettbewerb werden durch das Zivil- und Strafrecht verurteilt:

- Die Fälschung (Nachbau) von Originalteilen zieht die zivil- und strafrechtliche Haftung des Herstellers, des Wiederverkäufers und in bestimmten Fällen auch des Benutzers nach sich.

- Der unlautere Wettbewerb zieht **die zivilrechtliche Haftung des Herstellers und des Wiederverkäufers von Nachbauteilen nach sich**; sie ziehen aus dieser Operation einen ungerechtfertigten Nutzen, und verfälschen die normalen Regeln des Wettbewerbs, indem sie die Forschungs- und Konzeptionsarbeit sowie das Know-How der Konstrukteure nutzen.

NORMES ET RÈGLEMENTATION

STANDARDS AND REGULATIONS

NORM UND REGLEMENTIERUNG

Les extraits de réglementation sont disponibles sur notre site web.

Les éléments sont extraits du règlement ECE R48 concernant la majorité des véhicules.
Se référer au règlement pour des configurations particulières.

Les produits doivent être homologués selon le dernier amendement en vigueur
L'utilisateur est responsable de la conformité de l'équipement de son véhicule.

VIGNAL s'engage sur la conformité de ses produits.

ADR

Le sigle ADR signifie que le produit est homologué pour le montage sur des véhicules qui satisfont aux dispositions ADR (accord européen relatif au transport international des marchandises dangereuses par route).

Les produits ADR ont un indice de protection d'au moins IP54.

L'indice de protection IP détermine le degré de protection du matériel contre la pénétration des corps solides (1er chiffre) et des liquides (2ème chiffre).



Exemple : IP54

1er chiffre : 5 => Protégé contre les infiltrations de poussière

2ème chiffre : 4 => Protégé contre les projections d'eau (haute pression) de toutes les directions

The regulation extracts are available on our website.

The elements are extracts from the ECE R48 regulation which concern most of the vehicles.
Please refer to the regulation for any special configuration.

The products must be homologated according to the last amendments in force.
The user is responsible for the conformity of its vehicle's equipment.

VIGNAL is committed to the conformity of its products

ADR

The ADR sign means the product is homologated on vehicles which are under ADR regulations (European Agreement concerning the International Carriage of Dangerous Goods by Road).

The ADR products have an ingress protection rating of at least IP54.

IP Code classifies and rates the degrees of protection provided against the intrusion of solid objects (1st number) and water (2d number)



Example : IP54

1st number : 5 => Protected against dust

2d number : 4 => Protected against splashing water from all directions

Auszüge aus der Reglementierung sind auf unserer Webseite ersichtlich.

Es handelt sich um die für die meisten Fahrzeuge zutreffenden Auszüge der Reglementierung ECE R48.
Für Sonderfälle sehen Sie bitte die komplette Reglementierung ein.

Die Produkte sind nach dem aktuellstem Änderungsstand zu homologieren.
Der Fahrzeugführer ist für die zulässige Ausrüstung seines Fahrzeuges verantwortlich.

VIGNAL garantiert die Konformität der Produkte.

ADR

Das ADR Zeichen bedeutet, dass das Produkt für den Einbau in Fahrzeuge mit ADR Zulassung (Europäisches Übereinkommen über die internationale Beförderung gefährlicher Güter auf der Straße) geeignet ist. ADR-Produkte haben einen Schutzfaktor von mindestens IP54.

Der IP Schutzfaktor bestimmt den Schutzgrad eines Bauteils gegenüber das Eindringen von festen Körpern (erste Ziffer) und von Flüssigkeiten (zweite Ziffer).



Beispiel : IP 54

Erste Ziffer : 5 => Schutz gegen das eindringen von Staub

Zweite Ziffer : 4 => Schutz gegen Spritzwasse aus allen Richtungen

NORMES ET RÈGLEMENTATION
STANDARDS AND REGULATIONS
NORM UND REGLEMENTIERUNG

Indice de protection

Indice	1 ^{er} chiffre (dizaine) = Protection contre la poussière	2 ^{ème} chiffre (unité) = Protection contre l'eau
0	Aucune protection.	Aucune protection.
1	Protégé contre les corps solides supérieurs à 50 mm.	Protégé contre les chutes verticales de gouttes d'eau.
2	Protégé contre les corps solides supérieurs à 12,5 mm.	Protégé contre les chutes de gouttes d'eau jusqu'à 15° de la verticale.
3	Protégé contre les corps solides supérieurs à 2,5 mm.	Protégé contre l'eau en pluie jusqu'à 60° de la verticale.
4	Protégé contre les corps solides supérieurs à 1 mm.	Protégé contre les projections d'eau de toutes directions.
5	Protégé contre les poussières.	Protégé contre les jets d'eau de toutes directions à la lance.
6	Totalement protégé contre les poussières.	Protégé contre les forts jets d'eau de toutes directions à la lance.
7	-	Protégé contre les effets de l'immersion (jusqu'à 1m).
8	-	Matériel submersible dans des conditions spécifiées (immersion prolongée) au delà de 1 m et pendant 30 minutes.
9K	-	Protection contre le nettoyage à haute pression.

International Protection

Level	1 st digit = Solid particles protection	2 nd digit = Liquid ingress protection
0	Not protected.	Not protected.
1	Protected against solid objects superior to 50 mm.	Protected against vertical dripping.
2	Protected against solid objects superior to 12,5 mm.	Protected against dripping (inclined 15°).
3	Protected against solid objects superior to 2,5 mm.	Protected against spraying water.
4	Protected against solid objects superior to 1 mm.	Protected against splashing of water from any direction.
5	Dust protected.	Protected against water jets by a nozzle.
6	Dust tight.	Protected against powerful water jets by a nozzle.
7	-	Protected against immersion up to 1 m.
8	-	Submersible equipment under specified conditions beyond 1 m for 30 minutes.
9K	-	Protected against close-range high pressure.

Schutzart

Kennziffer	Erste Kennziffer = Schutz gegen Fremdkörper	Zweite Kennziffer = Bedeutung: Schutz gegen Wasser
0	kein Schutz.	kein Schutz.
1	Geschützt gegen feste Fremdkörper mit Durchmesser ab 50 mm.	Schutz gegen Tropfwasser.
2	Geschützt gegen feste Fremdkörper mit Durchmesser ab 12,5 mm.	Schutz gegen fallendes Tropfwasser, wenn das Gehäuse bis zu 15° geneigt ist.
3	Geschützt gegen feste Fremdkörper mit Durchmesser ab 2,5 mm.	Schutz gegen fallendes Sprühwasser bis 60° gegen die Senkrechte.
4	Geschützt gegen feste Fremdkörper mit Durchmesser ab 1,0 mm.	Schutz gegen allseitiges Spritzwasser.
5	Geschützt gegen Staub in schädigender Menge.	Schutz gegen Strahlwasser (Düse) aus beliebigem Winkel.
6	Staubdicht.	Schutz gegen starkes Strahlwasser.
7	-	Schutz gegen zeitweiliges Untertauchen.
8	-	Schutz gegen dauerndes Untertauchen.
9K	-	Schutz gegen Wasser bei Hochdruck-/Dampfstrahlreinigung, spezifisch für Straßenfahrzeuge.



VIGNAL

2021



NBB

ABL

VIGNAL

CEA

SACEX

VIGNAL GROUP

19, avenue du 24 Août 1944
69960 Corbas
FRANCE

E-mail : contact@vignal-group.com
Site web : www.vignal-group.com

VIGNAL SYSTEMS
19, avenue du 24 Août 1944
69960 Corbas
FRANCE

VIGNAL ABL
3, rue de la Cotonnière
Z.I. du Chemin Vert
14000 Caen
FRANCE

VIGNAL C.E.A.
11, Via Alla Rossa
6862 Rancate
SWITZERLAND

VIGNAL CHANGZHOU
Building B2, N° 585
Huanghe West Road
Xinbei District
Changzhou City, Jiangsu Province
CHINA

VIGNAL ABL USA
660 Golf Club Blvd
Mosinee, WI 54455
USA



Ref: 99999CAD



www.vignal-group.com